



Karea

Switch & Socket Outlet Series



Karea Switch & Socket Outlet Series

Colourful Products



It is possible to design an interior with Karea series.
Reflect your style within your environment.

Functions



One Way Switch



Two-Circuit Switch



3 Circuit Switch



HDMI Socket (with jack)



Socket Outlet with Earthing
Pin and Child Protection



Audio Switch 10 W



Dimmer



Data Socket Outlet

The comfort you want in decorations

Korea carrying the perfection of classic with its horizontal frames and practical and useful structure, it became more unique and authentic with vertical framework which is becoming a new trend.



Multi Frames



Double Horizontal Frame



Triple Horizontal Frame



Quartet Horizontal Frame



Fiftet Horizontal Frame



Sixtet Horizontal Frame



Double Vertical Frame



Triple Vertical Frame



Quartet Vertical Frame

Colourful Products



001 White



010 Beige



065 Metallic Silver



057 Dore



052 Green



050 Fume



100 Pearl



096 Brown



105 Natural Pine



103 Natural Cherry



101 Natural Oak

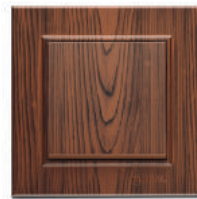

102 Natural Walnut

Pastel Colour Frames



078 Lilac



093 Rose



074 Yellow



092 Blue



095 Light Lilac



091 Green



094 Orange

You can merge rich color options with the design of your environment in order to create combinations suiting your life style.

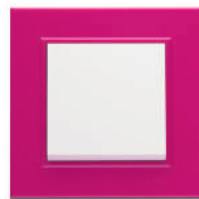

085 Magenta

Karea Switch & Socket Outlet Series



One Way Switch *

56001001
10 AX, 250 V~
EN 60669-1
Piece in Box / Package - 12 / 120



One Way Switch Illuminated *

56001021
10 AX, 250 V~
EN 60669-1
Piece in Box / Package - 12 / 120



Two-Circuit Switch *

56001003
10 AX, 250 V~
EN 60669-1
Piece in Box / Package - 12 / 120



Two-Circuit Switch Illuminated *

56001023
10 AX, 250 V~
EN 60669-1
Piece in Box / Package - 12 / 120



Light Switch *

56001004
10 A, 250 V~
EN 60669-1
Piece in Box / Package - 12 / 120



Light Switch Illuminated *

56001024
10 A, 250 V~
EN 60669-1
Piece in Box / Package - 12 / 120



Two-Way Switch *

56001005
10 AX, 250 V~
EN 60669-1
Piece in Box / Package - 12 / 120



Two-Way Switch Illuminated *

56001025
10 AX, 250 V~
EN 60669-1
Piece in Box / Package - 12 / 120



Door Switch *

56001096
10 A, 250 V~
EN 60669-1
Piece in Box / Package - 12 / 120



Door Switch Illuminated *

56001097
10 A, 250 V~
EN 60669-1
Piece in Box / Package - 12 / 120



Intermediate Switch *

56001020
10 AX, 250 V~
EN 60669-1
Piece in Box / Package - 12 / 120



Intermediate Switch Illuminated *

56001040
10 AX, 250 V~
EN 60669-1
Piece in Box / Package - 12 / 120

* Marked products are available with screwless terminal option.



Bell Switch *
 56001050
 10 A, 250 V~
 EN 60669-1
 Piece in Box / Package - 12 / 120



Bell Switch Illuminated 12V *
 56001085
 10 A, 12 V~
 EN 60669-1
 Piece in Box / Package - 12 / 120



Bell Switch With Label *
 56001010
 10 A, 250 V~
 EN 60669-1
 Piece in Box / Package - 12 / 120



Bell Switch Illuminated *
 56001070
 10 A, 250 V~
 EN 60669-1
 Piece in Box / Package - 12 / 120



**Bell Switch Illuminated *
 With Label 12V**
 56001030
 10 A, 12 V~
 EN 60669-1
 Piece in Box / Package - 12 / 120



Control Switch 2-Pole *
 56001071
 16 A, 250 V~
 EN 60669-1
 Piece in Box / Package - 12 / 120



Double Two-Way Switch
 56001026
 10 AX, 250 V~
 EN 60669-1
 Piece in Box / Package - 12 / 120



Shutter Push-Button *
 56001041
 10 A, 250 V~
 EN 60669-1
 Piece in Box / Package - 12 / 120



3 Circuit Switch
 56001091
 10 AX, 250 V~
 EN 60669-1
 Piece in Box / Package - 12 / 120



3 Gang 3 Pole Switch
 56001092
 10 AX, 250 V~
 EN 60669-1
 Piece in Box / Package - 12 / 120



1 Gang 3 Circuit Switch
 56001094
 10 AX, 250 V~
 EN 60669-1
 Piece in Box / Package - 12 / 120



1 Gang 3 Pole Switch
 56001095
 10 AX, 250 V~
 EN 60669-1
 Piece in Box / Package - 12 / 120

Karea Switch & Socket Outlet Series



Socket Outlet

56001022

16 A, 250 V~
IEC 60884-1
Piece in Box / Package - 12 / 120



Schuko Socket Outlet *

56001028

16 A, 250 V~
IEC 60884-1
Piece in Box / Package - 12 / 120



Schuko Socket Outlet with Lid *

56001029

16 A, 250 V~
IEC 60884-1
Piece in Box / Package - 12 / 120



Schuko Socket Outlet with Child Protection and Lid *

56001254

16 A, 250 V~
IEC 60884-1
Piece in Box / Package - 12 / 120



Socket Outlet with Earthing Pin *

56001019

16 A, 250 V~
IEC 60884-1
Piece in Box / Package - 12 / 120



Socket Outlet with Child Protection

56001052

16 A, 250 V~
IEC 60884-1
Piece in Box / Package - 12 / 120



Socket Outlet with Earthing Pin and Child Protection *

56001053

16 A, 250 V~
IEC 60884-1
Piece in Box / Package - 12 / 120



Schuko Socket Outlet with Child Protection *

56001058

16 A, 250 V~
IEC 60884-1
Piece in Box / Package - 12 / 120



Double Socket Outlet with Earthing Pin

56001018

16 A, 250 V~
IEC 60884-1
Piece in Box / Package - 12 / 120



Double Socket Outlet

56001017

16 A, 250 V~
IEC 60884-1
Piece in Box / Package - 12 / 120



Double Schuko Socket Outlet

56001082

16 A, 250 V~
IEC 60884-1
Piece in Box / Package - 12 / 120

* Marked products are available with screwless terminal option.



Antenna Socket Through
6 dB Female
 56001007
 TSE K 72
 Piece in Box / Package - 12 / 120



Antenna Socket End
4 dB Female
 56001027
 TSE K 72
 Piece in Box / Package - 12 / 120



Antenna Socket Through
Male 6 dB
 56001043
 TSE K 72
 Piece in Box / Package - 12 / 120



Antenna Socket End
Male 4 dB
 56001044
 TSE K 72
 Piece in Box / Package - 12 / 120



TV-RF Antenna Socket Through 7 dB
 56001060
 TSE K 72
 Piece in Box / Package - 12 / 120



TV-RF Antenna Socket End 1.5 dB
 56001065
 TSE K 72
 Piece in Box / Package - 12 / 120



TV-SAT Antenna Socket Through
4 dB
 56001083
 TSE K 72
 Piece in Box / Package - 12 / 120



TV-SAT Antenna Socket End
1 dB
 56001098
 TSE K 72
 Piece in Box / Package - 12 / 120



TV-RF-SAT Antenna Socket
Through 4 dB
 56001067
 TSE K 72
 Piece in Box / Package - 12 / 120



TV-RF-SAT Antenna Socket End
1.5 dB
 56001066
 TSE K 72
 Piece in Box / Package - 12 / 120



Telephone Socket
 56001014
 TSE K 71
 Piece in Box / Package - 12 / 120



Double Telephone Socket
 56001034
 TSE K 71
 Piece in Box / Package - 12 / 120

Karea Switch & Socket Outlet Series



Double Data Socket Outlet (1xCat5)
56001035
TSE K 71
Piece in Box / Package - 12 / 120



Double Data Socket Outlet (2xCat5)
56001036
TSE K 71
Piece in Box / Package - 12 / 120



**Data Socket Outlet
(Cat5+Telephone Socket)**
56001037
TSE K 71
Piece in Box / Package - 12 / 120



Data Socket Outlet (empty)
56001038
TSE K 71
Piece in Box / Package - 12 / 120



Loudspeaker - connection, 1 gang
56001449
TSE K 71
Piece in Box / Package - 12 / 120



Dimmer
56001011
60-600 W, 250 V~
EN 60669-2-2
Piece in Box / Package - 10 / 100



Dimmer Coil Filtered
56001031
60-600 W, 250 V~
EN 60669-2-2
Piece in Box / Package - 10 / 100



Dimmer
56001093
60-1000 W, 250 V~
EN 60669-2-2
Piece in Box / Package - 10 / 100



1-10V Led Dimmer
56001459
IEC 60669-2-1
50Hz, 230 V~
Piece in Box / Package - 10 / 100



**Remote Controlled Dimmer(IR)
Coil Filtered**
56001045
60-300 W, 250 V~
EN 60669-2-2
Piece in Box / Package - 10 / 100



Audio Switch 10 W
56001086
10 W
Piece in Box / Package - 6 / 60



Emergency-Light
56001055
250 V~
Piece in Box / Package - 6 / 60



Warning Bell
56001056
250 V~
Piece in Box / Package - 6 / 60



Delayed Energy Saver (Without Relay)*
56001046
10A, 220 V~
Piece in Box / Package - 10 / 100



Energy Saver (Without Relay)*
56001183
10A, 220 V~
Piece in Box / Package - 12 / 120



Electro-Magnetic Energy Saver*
56001301
12 V ~
Piece in Box / Package - 12 / 120



Radio Frequency Energy Saver*
56001302
12 V ~
Piece in Box / Package - 12 / 120



Cooling Switch
56001084
16 A, 250 V~
Piece in Box / Package - 12 / 120



Surge-Protective Socket Outlet with Child Protection
56001139K
16 A, 250 V~
Piece in Box / Package - 5 / 30



HDMI Socket (with jack)
56001494
Piece in Box / Package - 12 / 120



USB Socket (with jack)
56001495
Piece in Box / Package - 12 / 120



USB Charging Socket
56001465
Input: 250V AC, Output: 5V DC, 2A
Piece in Box / Package - 12 / 120



USB Charging Socket
56001A80
Piece in Box / Package - 12 / 120

* Energy saver product visuals are given as representations, the card must be ordered separately.

Karea Switch & Socket Outlet Series



Frame
56001701



Double Horizontal Frame
56001702

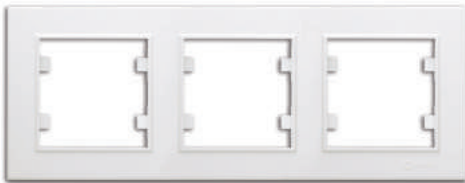

Triple Horizontal Frame
56001703



Quartet Horizontal Frame
56001704



Fiftet Horizontal Frame
56001705



Sixtet Horizontal Frame
56001706



Double Vertical Frame
56001707



Triple Vertical Frame
56001708



Quartet Vertical Frame
56001709

Sales Options

1st Sales Option - Complete Product



Complete Product

2nd Sales Option - Module (with Rocker / Cover Plate) and Frame



Module

(With Rocker / Cover Plate)

+



Frame

=



Complete Product

Technical Drawings

Frame

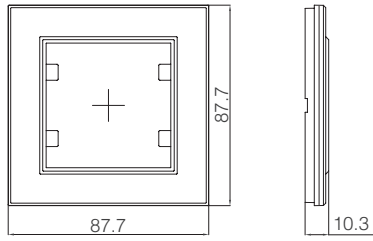

One Way Switch

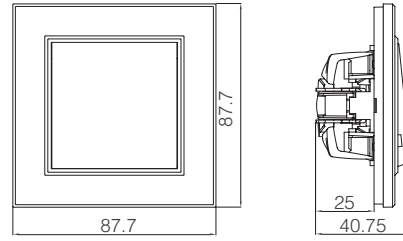

Schuko Socket Outlet

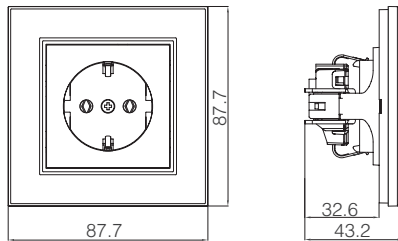

Double Schuko Socket Outlet

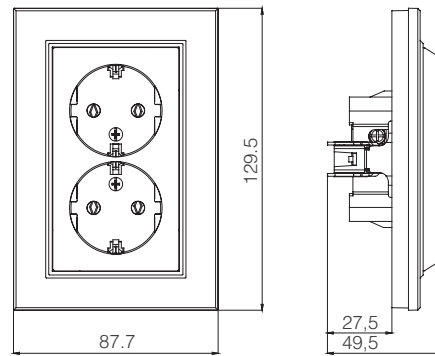

Double Horizontal Frame

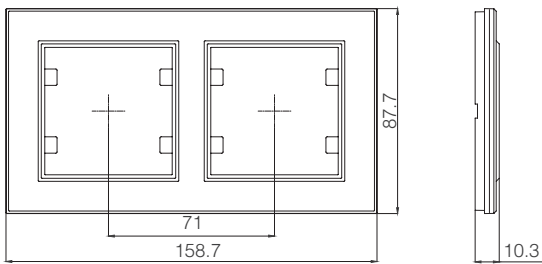

Triple Horizontal Frame

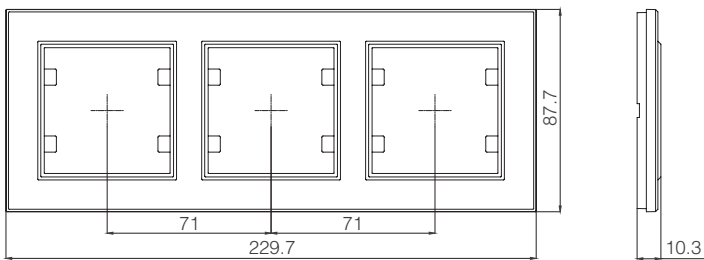

Quartet Horizontal Frame

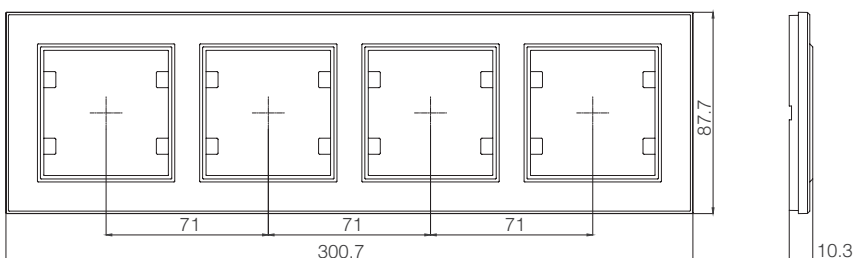

Fiftet Horizontal Frame

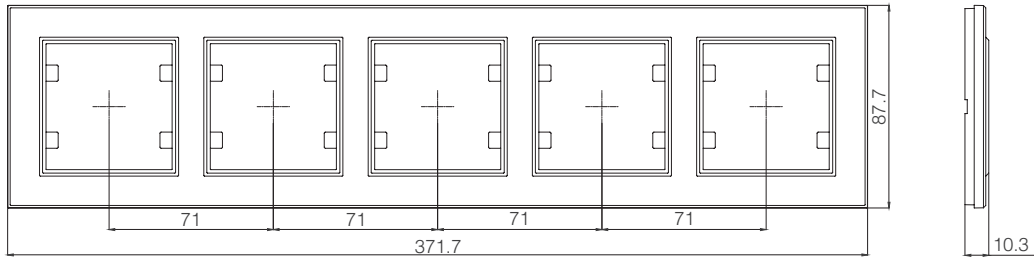

Sixtet Horizontal Frame

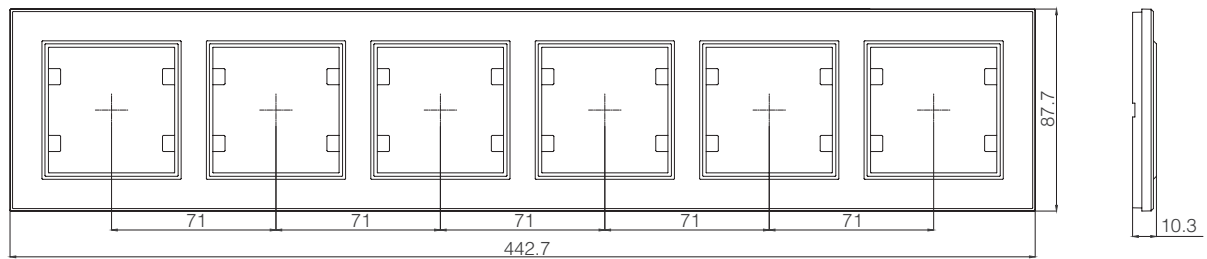

Double Vertical Frame

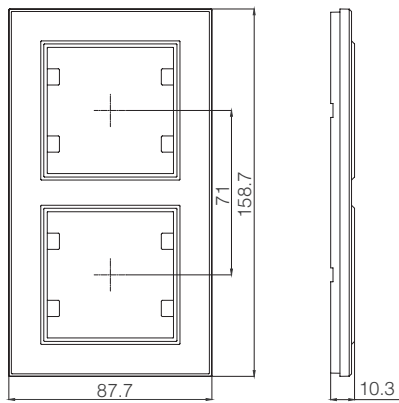

Triple Vertical Frame

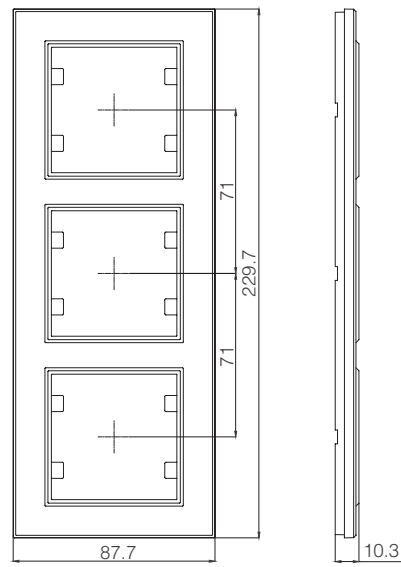

Quartet Vertical Frame

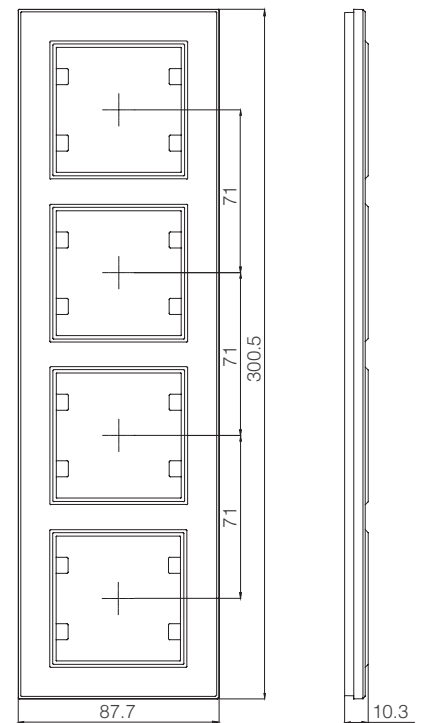

Karea Switch & Socket Outlet Series

1st Sales Option - Complete Product

Product Name	Code No.	Piece in Box	Piece in Package	Gross Weight (kg)	Size of Package (mm)
Switch Group					
• One Way Switch	56 xxx 001	12	120	11,79	315 x 495 x 280
• One Way Switch Illuminated	56 xxx 021	12	120	12,11	315 x 495 x 280
• Two-Circuit Switch	56 xxx 003	12	120	12,40	315 x 495 x 280
• Two-Circuit Switch Illuminated	56 xxx 023	12	120	12,65	315 x 495 x 280
• Light Switch	56 xxx 004	12	120	11,75	315 x 495 x 280
• Light Switch Illuminated	56 xxx 024	12	120	12,19	315 x 495 x 280
Double Light	56 xxx 441	12	120	11,88	315 x 495 x 280
• Two-Way Switch	56 xxx 005	12	120	12,01	315 x 495 x 280
• Two-Way Switch Illuminated	56 xxx 025	12	120	12,32	315 x 495 x 280
• Door Switch	56 xxx 096	12	120	11,80	315 x 495 x 280
• Door Switch Illuminated	56 xxx 097	12	120	12,15	315 x 495 x 280
• Intermediate Switch	56 xxx 020	12	120	11,93	315 x 495 x 280
• Intermediate Switch Illuminated	56 xxx 040	12	120	12,40	315 x 495 x 280
• Bell Switch	56 xxx 050	12	120	11,84	315 x 495 x 280
• Bell Switch Illuminated 12V	56 xxx 085	12	120	11,84	315 x 495 x 280
• Bell Switch Illuminated	56 xxx 070	12	120	11,84	315 x 495 x 280
• Bell Switch With Label	56 xxx 010	12	120	11,79	315 x 495 x 280
• Bell Switch Illuminated With Label 12V	56 xxx 030	12	120	11,70	315 x 495 x 280
3 Circuit Switch	56 xxx 091	12	120	12,15	315 x 495 x 280
3 Gang 3 Pole Switch	56 xxx 092	12	120	12,15	315 x 495 x 280
1 Gang 3 Circuit Switch	56 xxx 094	12	120	12,15	315 x 495 x 280
1 Gang 3 Pole Switch	56 xxx 095	12	120	12,15	315 x 495 x 280
Cooling Switch	56 xxx 084	12	120	13,15	315 x 495 x 280
Double Two-Way Switch	56 xxx 026	12	120	12,80	315 x 495 x 280
• Shutter Push-Button	56 xxx 041	12	120	12,53	315 x 495 x 280
One Gang Shutter Push-Button	56 xxx 279	12	120	12,33	315 x 495 x 280
• Control Switch 2-Pole	56 xxx 071	12	120	10,63	315 x 495 x 280
Hotel Room Signalling Switch	56 xxx 252	12	120	12,11	315 x 495 x 280
Hotel Room Bell Switch	56 xxx 253	12	120	12,08	315 x 495 x 280
Emergency Switch with Cord	56 xxx 128	12	120	10,82	285 x 505 x 280
Socket Outlet Group					
Socket Outlet	56 xxx 022	12	120	16,60	315 x 495 x 280
Schuko Socket Outlet	56 xxx 028	12	120	11,78	315 x 495 x 280
Schuko Socket Outlet Screwless	56 xxx 172	12	120	11,96	315 x 495 x 280
Schuko Socket Outlet with Lid	56 xxx 029	12	120	12,04	320 x 485 x 300
Schuko Socket Outlet Screwless with Lid	56 xxx 099	12	120	11,22	315 x 495 x 280
Schuko Socket Outlet with Child Protection and Lid	56 xxx 254	12	120	12,23	320 x 485 x 300
Schuko Socket Outlet Screwless with Child Protection and Lid	56 xxx 255	12	120	12,34	315 x 495 x 280
Socket Outlet with Earthing Pin	56 xxx 019	12	120	13,11	315 x 495 x 280
Socket Outlet Screwless with Earthing Pin	56 xxx 173	12	120	12,87	315 x 495 x 280
Socket Outlet with Earthing Pin and Lid	56 xxx 016	12	120	12,42	320 x 485 x 300
Socket Outlet with Child Protection	56 xxx 052	12	120	10,61	315 x 495 x 280
Socket Outlet with Earthing Pin and Child Protection	56 xxx 053	12	120	12,15	315 x 495 x 280
Socket Outlet Screwless with Earthing Pin and Child Protection	56 xxx 198	12	120	12,15	315 x 495 x 280
Socket Outlet with Child Protection Schuko Socket Outlet with	56 xxx 300	12	120	13,56	320 x 485 x 300
Schuko Socket Outlet with Child Protection	56 xxx 058	12	120	10,61	315 x 495 x 280
Schuko Socket Outlet Screwless with Child Protection	56 xxx 174	12	120	10,61	315 x 495 x 280
Double Socket Outlet with Earthing Pin	56 xxx 018	12	120	10,61	335 x 475 x 300
Double Socket Outlet	56 xxx 017	12	120	10,61	320 x 485 x 300
Double Schuko Socket Outlet	56 xxx 082	12	120	10,61	410 x 485 x 310

1st Sales Option - Complete Product



Complete Product

Product Name	Code No.	Piece in Box	Piece in Package	Gross Weight (kg)	Size of Package (mm)
--------------	----------	--------------	------------------	-------------------	----------------------

Tv Socket Outlet Group

Antenna Socket Through 6 dB Female	56 xxx 007	12	120	15,58	315 x 495 x 280
Antenna Socket End 4 dB Female	56 xxx 027	12	120	15,58	315 x 495 x 280
Antenna Socket End 0.5 dB Metal Case	56 xxx 087	12	120	15,58	315 x 495 x 280
Antenna Socket Through 11 dB Metal Case *	56 xxx 088	12	120	15,58	315 x 495 x 280
TV Antenna Socket Non-Resistance	56 xxx 142	12	120	10,38	315 x 495 x 280
Antenna Socket Through Male	56 xxx 043	12	120	10,30	285 x 505 x 280
Antenna Socket End Male	56 xxx 044	12	120	10,30	285 x 505 x 280
TV-RF Antenna Socket Through 7 dB**	56 xxx 060	12	120	9,99	315 x 495 x 280
TV-RF Antenna Socket End 1.5 dB	56 xxx 065	12	120	10,77	315 x 495 x 280
TV-SAT Antenna Socket End 1 dB	56 xxx 098	12	120	10,77	315 x 495 x 280
TV-SAT Antenna Socket Through 4 dB	56 xxx 083	12	120	9,99	315 x 495 x 280
TV-RF-SAT Antenna Socket End 1.5 dB	56 xxx 066	12	120	9,99	315 x 495 x 280
TV-RF-SAT Antenna Socket Through 4 dB	56 xxx 067	12	120	9,99	315 x 495 x 280
SAT Antenna Socket Through	56 xxx 133	12	120	9,99	315 x 495 x 280
SAT Antenna Socket End	56 xxx 134	12	120	10,66	315 x 495 x 280

Data Transmission Group

Telephone Socket	56 xxx 014	12	120	11,18	315 x 495 x 280
Double Telephone Socket	56 xxx 034	12	120	10,36	315 x 495 x 280
Double Telephone Socket (1xCat3) with Data Connector	56 xxx 042	12	120	9,98	315 x 495 x 280
Double Data Socket Outlet (1xCat5)	56 xxx 035	12	120	9,99	315 x 495 x 280
Double Data Socket Outlet (2xCat5)	56 xxx 036	12	120	9,99	315 x 495 x 280
Data Socket Outlet (Cat5+Telephone Socket)	56 xxx 037	12	120	9,99	315 x 495 x 280
Data Socket Outlet (Empty)	56 xxx 038	12	120	9,99	315 x 495 x 280
Double Data Socket Outlet (1xCat6)	56 xxx 135	12	120	10,66	315 x 495 x 280
Double Data Socket Outlet (2xCat6)	56 xxx 136	12	120	9,99	315 x 495 x 280
Data Socket Outlet (Cat3+Cat6)	56 xxx 137	12	120	9,99	315 x 495 x 280
Double Data Socket-Outlet (1xCat 3)	56 xxx 075	12	120	10,04	315 x 495 x 280
Data Socket Outlet (2xCat3)	56 xxx 076	12	120	9,99	315 x 495 x 280
Loudspeaker - connection, 1 gang	56 xxx 449	12	120	10,66	315 x 495 x 280
HDMI Socket (with jack)	56 xxx 494	12	120	9,83	315 x 495 x 280
USB Socket (with jack)	56 xxx 495	12	120	9,83	315 x 495 x 280

Electronic Group

Dimmer 60-600W	56 xxx 011	10	100	13,42	370 x 485 x 260
Dimmer Coil Filtered 60-600W	56 xxx 031	10	100	18,91	410 x 545 x 315
Dimmer 60-1000W	56 xxx 093	10	100	11,73	370 x 485 x 260
1-10V Led Dimmer	56 xxx 459	10	100	15,22	380 x 495 x 310
Remote Controlled Dimmer(IR) Coil Filtered 60-300W	56 xxx 045	10	100	15,76	410 x 545 x 315
Audio Switch 10 W	56 xxx 086	6	60	8,11	195 x 385 x 95
Emergency-Light	56 xxx 055	6	60	10,24	195 x 385 x 95
Warning Bell	56 xxx 056	6	60	7,76	195 x 385 x 95
■ Delayed Energy Saver (Without Relay)	56 xxx 046	12	120	12,07	410 x 545 x 315
■ Energy Saver (Without Relay)	56 xxx 183	12	120	12,45	285 x 475 x 275
■ Electro-Magnetic Energy Saver	56 xxx 301	12	120	7,03	365 x 472 x 215
■ Radio Frequency Energy saver	56 xxx 302	12	120	7,62	365 x 472 x 215
Surge-Protective Socket Outlet with Child Protection	56 xxx 139K	5	30	4,71	265 x 425 x 175
USB Charging Socket	56 xxx 465	12	120	12,94	315 x 495 x 280
Double USB Charge Socket	56 xxx A80	12	120	12,45	315 x 495 x 280

(*) Marked products are available with screwless terminal option. (*) 14 dB and 18 dB versions are available. (**) 10 - 12 - 15 - 20 dB versions are available.

■ See page 231 for relay options for marked products.

SAMPLE

White	Product Name	Code No
	Screw Switch	56 001 0 01
	Screwless Terminal Switch	56 001 1 01

When you order screwless terminals must use '1' instead of '0' at the third digit of the item code.

Within the product codes showing 'xxx', enter the color from the table below.

Colors	Code No	Colors	Code No	Colors	Code No
	xxx		xxx		xxx
White	001	Fume	050	Pearl	100
Beige	010	Brown	096	Natural Oak	101
Metallic Silver	065	Light Brown	097	Natural Walnut	102
Dore	057	Brown / Light Brown	009	Natural Cherry	103
Green	052	Black	111	Natural Pine	105

Karea Switch & Socket Outlet Series

2nd Sales Option - Module (With Rocker / Cover Plate) and Frame

a) Module (With Rocker / Cover Plate)

Product Name	Code No.	Piece in Box	Piece in Package	Gross Weight (kg)	Size of Package (mm)
Switch Group					
• One Way Switch, Module with Rocker	57 xxx 001	12	120	8,58	365 x 470 x 215
• One Way Switch Illuminated, Module with Rocker	57 xxx 021	12	120	8,87	365 x 472 x 215
• Two-Circuit Switch, Module with Rocker	57 xxx 003	12	120	9,19	365 x 470 x 215
• Two-Circuit Switch Illuminated, Module with Rocker	57 xxx 023	12	120	9,36	365 x 472 x 215
• Light Switch, Module with Rocker	57 xxx 004	12	120	8,63	365 x 470 x 215
• Light Switch Illuminated, Module with Rocker	57 xxx 024	12	120	8,92	365 x 472 x 215
• Double Light Module and Rocker	57 xxx 441	12	120	9,62	365 x 472 x 215
• Two-Way Switch, Module with Rocker	57 xxx 005	12	120	8,94	365 x 470 x 215
• Two-Way Switch Illuminated, Module with Rocker	57 xxx 025	12	120	9,22	365 x 472 x 215
• Door Switch, Module with Rocker	57 xxx 096	12	120	8,63	365 x 472 x 215
• Door Switch Illuminated, Module with Rocker	57 xxx 097	12	120	8,92	365 x 472 x 215
• Intermediate Switch, Module with Rocker	57 xxx 020	12	120	9,30	365 x 472 x 215
• Intermediate Switch Illuminated, Module with Rocker	57 xxx 040	12	120	9,54	355 x 435 x 210
• 3 Circuit Switch, Module with Rocker	57 xxx 091	12	120	8,61	365 x 472 x 215
• 3 Gang 3 Pole Switch, Module with Rocker	57 xxx 092	12	120	8,61	365 x 472 x 215
• 1 Gang 3 Circuit Switch, Module with Rocker	57 xxx 094	12	120	8,61	365 x 472 x 215
• 1 Gang 3 Pole Switch, Module with Rocker	57 xxx 095	12	120	8,61	365 x 472 x 215
• Cooling Switch, Module with Rocker	57 xxx 084	12	120	9,61	365 x 472 x 215
• Double Two-Way Switch, Module with Rocker	57 xxx 026	12	120	10,94	285 x 475 x 275
• Shutter Push-Button, Module with Rocker	57 xxx 041	12	120	9,42	365 x 472 x 215
• One Gang Shutter Push-Button, Module with Rocker	57 xxx 279	12	120	8,94	365 x 472 x 215
• Bell Switch, Module with Rocker	57 xxx 050	12	120	8,86	365 x 472 x 215
• Bell Switch With Label, Module with Rocker	57 xxx 010	12	120	8,78	365 x 472 x 215
• Bell Switch Illuminated 12V, Module with Rocker	57 xxx 085	12	120	9,08	365 x 472 x 215
• Bell Switch Illuminated, Module with Rocker	57 xxx 070	12	120	9,08	365 x 472 x 215
• Bell Switch Illuminated With Label 12V, Module with Rocker	57 xxx 030	12	120	9,08	365 x 472 x 215
• Control Switch 2-Pole, Module with Rocker	57 xxx 071	12	120	8,68	365 x 472 x 215
• Hotel Room Signalling Switch, Module with Rocker	57 xxx 252	12	120	8,85	365 x 472 x 215
• Hotel Room Bell Switch, Module with Rocker	57 xxx 253	12	120	9,01	365 x 472 x 215
• Emergency Switch with Cord, Module with Rocker	57 xxx 128	12	120	8,63	365 x 472 x 215
• Cable Outlet Module	57 xxx A64	12	120	7,25	365 x 472 x 215
• Cavity Module	57 xxx A63	12	120	6,42	365 x 472 x 215

Socket Outlet Group

Socket Outlet, Module with Cover Plate	57 xxx 022	12	120	7,54	365 x 472 x 215
Schuko Socket Outlet, Module with Cover Plate	57 xxx 028	12	120	10,35	365 x 470 x 215
Schuko Socket Outlet Screwless, Module with Cover Plate	57 xxx 172	12	120	9,35	365 x 472 x 215
Schuko Socket Outlet with Lid, Module with Cover Plate	57 xxx 029	12	120	12,05	280 x 480 x 280
Schuko Socket Outlet Screwless with Lid, Module with Cover Plate	57 xxx 099	12	120	8,90	285 x 475 x 275
Socket Outlet with Earthing Pin, Module with Cover Plate	57 xxx 019	12	120	8,78	365 x 472 x 215
Socket Outlet Screwless with Earthing Pin, Module with Cover Plate	57 xxx 173	12	120	8,79	365 x 472 x 215
Socket Outlet with Earthing Pin and Lid, Module with Cover Plate	57 xxx 016	12	120	9,94	285 x 475 x 275
Socket Outlet with Child Protection, Module with Cover Plate	57 xxx 052	12	120	8,86	365 x 472 x 215
Socket Outlet with Earthing Pin and Child Protection, Module with Cover Plate	57 xxx 053	12	120	8,78	365 x 472 x 215
Socket Outlet Screwless with Earthing Pin and Child Protection, Module with Cover Plate	57 xxx 198	12	120	8,78	365 x 472 x 215
Socket Outlet with Child Protection, Module with Cover Plate	57 xxx 300	12	120	10,18	285 x 475 x 275
Schuko Socket Outlet with Child Protection, Module with Cover Plate	57 xxx 058	12	120	8,78	365 x 470 x 215
Schuko Socket Outlet Screwless with Child Protection, Module with Cover Plate	57 xxx 174	12	120	8,72	365 x 472 x 215
Schuko Socket Outlet with Child Protection and Lid, Module with Cover Plate	57 xxx 254	12	120	9,67	365 x 472 x 215
Schuko Socket Outlet Screwless with Child Protection and Lid, Module with Cover Plate	57 xxx 255	12	120	8,90	285 x 475 x 275
Double Socket Outlet, Module with Cover Plate	57 xxx 017	12	120	9,74	285 x 475 x 275
Double Socket Outlet with Earthing Pin, Module with Cover Plate	57 xxx 018	12	120	11,60	335 x 475 x 300
Double Schuko Socket Outlet, Module with Cover Plate	57 xxx 082	12	120	11,35	335 x 475 x 300

2nd Sales Option - Module (With Rocker / Cover Plate) and Frame



Module
(With Rocker /
Cover Plate)

+



Frame

=



Complete Product

(*) Marked products are available with screwless terminal option.

SAMPLE

	Product Name	Code No
White	Screw Switch	57 001 0 01
	Screwless Terminal Switch	57 001 1 01

When you order screwless terminals must use '1'
instead of '0' at the third digit of the item code.

Product Name	Code No.	Piece in Box	Piece in Package	Gross Weight (kg)	Size of Package (mm)
Tv Socket Outlet Group					
Antenna Socket End 4 dB Female, Module with Cover Plate	57 xxx 027	12	120	8.01	365 x 472 x 215
Antenna Socket Through 6 dB Female, Module with Cover Plate	57 xxx 007	12	120	8.01	365 x 472 x 215
Antenna Socket End 0.5 dB Metal Case, Module with Cover Plate	57 xxx 087	12	120	8.70	365 x 472 x 215
Antenna Socket Through 11 dB Metal Case, Module with Cover Plate*	57 xxx 088	12	120	8.70	365 x 472 x 215
TV Antenna Socket Non-Resistance, Module with Cover Plate	57 xxx 142	12	120	7.95	365 x 472 x 215
SAT Antenna Socket Through, Module with Cover Plate	57 xxx 133	12	120	9.37	365 x 472 x 215
SAT Antenna Socket End, Module with Cover Plate	57 xxx 134	12	120	9.47	365 x 472 x 215
TV-RF Antenna Socket End 1.5 dB, Module with Cover Plate	57 xxx 065	12	120	12.44	365 x 472 x 215
TV-RF Antenna Socket Through 7 dB, Module with Cover Plate**	57 xxx 060	12	120	12.44	365 x 472 x 215
TV-RF-SAT Antenna Socket End 1.5 dB, Module with Cover Plate	57 xxx 066	12	120	12.38	365 x 472 x 215
TV-RF-SAT Antenna Socket Through 4 dB, Module with Cover Plate	57 xxx 067	12	120	12.50	365 x 472 x 215
TV-SAT Antenna Socket End 1 dB, Module with Cover Plate	57 xxx 098	12	120	12.74	365 x 472 x 215
TV-SAT Antenna Socket Through 4 dB, Module with Cover Plate	57 xxx 083	12	120	12.74	365 x 472 x 215

Data Transmission Group

Telephone Socket, Module with Cover Plate	57 xxx 014	12	120	7,70	365 x 472 x 215
Double Telephone Socket, Module with Cover Plate	57 xxx 034	12	120	7,72	365 x 472 x 215
Double Telephone Socket (1xCat3) Data Connector, Module with Cover Plate	57 xxx 042	12	120	7,72	365 x 477 x 220
Double Data Socket Outlet (1xCat5), Module with Cover Plate	57 xxx 035	12	120	7,62	285 x 475 x 275
Double Data Socket Outlet (2xCat5), Module with Cover Plate	57 xxx 036	12	120	8,20	285 x 475 x 275
Data Socket Outlet (Cat5+Telephone Socket), Module with Cover Plate	57 xxx 037	12	120	8,77	285 x 475 x 275
Data Socket Outlet (empty), Module with Cover Plate	57 xxx 038	12	120	7,62	285 x 475 x 275
Double Data Socket-Outlet (1xCat6) Module with Cover Plate	57 xxx 135	12	120	8,00	365 x 472 x 215
Double Data Socket-Outlet (2xCat6) Module with Cover Plate	57 xxx 136	12	120	8,67	365 x 472 x 215
Double Data Socket-Outlet (Cat3xCat6) Module with Cover Plate	57 xxx 137	12	120	8,42	365 x 472 x 215
Double Data Socket-Outlet (1xCat3) Module with Cover Plate	57 xxx 075	12	120	7,78	365 x 472 x 215
Loudspeaker - connection, 1 gang, Module with Cover Plate	57 xxx 449	12	120	7,49	365 x 472 x 215
HDMI Socket (with jack), Module with Cover Plate	57 xxx 494	12	120	7,67	365 x 472 x 215
USB Socket (with jack), Module with Cover Plate	57 xxx 495	12	120	7,64	365 x 472 x 215

Electronic Group

Dimmer 60-600W, Module with Cover Plate	57 xxx 011	12	120	10,60	335 x 475 x 300
Dimmer Coil Filtered 60-600W, Module with Cover Plate	57 xxx 031	12	120	16,05	335 x 475 x 300
Dimmer 60-1000W, Module with Cover Plate	57 xxx 093	12	120	10,57	335 x 475 x 300
Remote Controlled Dimmer(IR) Coil Filtered 60-300W, Module with Cover Plate	57 xxx 045	12	120	15,37	335 x 475 x 300
1-10V Led Dimmer, Module with Cover Plate	57 xxx 459	10	100	10,46	335 x 480 x 305
Audio Switch 10 W, Module with Cover Plate	57 xxx 086	6	60	4,59	315 x 420 x 195
Emergency-Light, Module with Cover Plate	57 xxx 055	6	60	3,20	315 x 420 x 195
Warning Bell, Module with Cover Plate	57 xxx 056	6	60	2,57	315 x 420 x 195
■ Delayed Energy Saver (Without Relay), Module with Cover Plate	57 xxx 046	12	120	8,95	365 x 472 x 215
■ Energy Saver (Without Relay), Module with Cover Plate	57 xxx 183	12	120	9,81	355 x 435 x 210
■ Electro-Magnetic Energy Saver, Module with Cover Plate	57 xxx 301	12	120	7,29	365 x 472 x 215
■ Radio Frequency Energy saver, Module with Cover Plate	57 xxx 302	12	120	7,43	365 x 472 x 215
Surge-Protective Socket Outlet with Child Protection, Module with Cover Plate	57 xxx 139K	5	30	3,70	190 x 290 x 272
USB Charging Socket, Module with Cover Plate	57 xxx 465	12	120	10,72	365 x 472 x 215
Double USB Charge Socket, Module with Cover Plate	57 xxx A80	12	120	10,23	365 x 472 x 215

(*) 14 dB and 18 dB versions are available. (**) 10 - 12 - 15 - 20 dB versions are available. (■) See page 231 for relay options for marked products.

b) Frames

Product Name	Code No.	Piece in Box	Piece in Package	Gross Weight (kg)	Size of Package (mm)
Frame	56 xxx 701	12	120	3,22	250 x 495 x 150
Double Horizontal Frame	56 xxx 702	25	250	9,52	385 x 495 x 270
Triple Horizontal Frame	56 xxx 703	20	200	10,66	415 x 505 x 280
Quartet Horizontal Frame	56 xxx 704	25	250	17,30	525 x 490 x 335
Fiftet Horizontal Frame	56 xxx 705	5	60	5,25	210 x 370 x 345
Sixtet Horizontal Frame	56 xxx 706	5	60	6,06	350 x 440 x 210
Double Vertical Frame	56 xxx 707	25	250	4,69	385 x 495 x 270
Triple Vertical Frame	56 xxx 708	20	200	9,31	415 x 505 x 280
Quartet Vertical Frame	56 xxx 709	25	250	16,43	525 x 495 x 340
Double Socket Outlet Frame	56 xxx 710	12	120	3,93	315 x 420 x 195

Please specify your choice of pastel colors by applying below color codes into the 'xxx' marked space.

	Code No		Code No
Colors	xxx	Colors	xxx
Yellow	074	Blue	092
Lilac	078	Rose	093
Magenta	085	Orange	094
Green	091	Light Lilac	095

Within frame codes showing 'xxx', enter the color codes from the table below.

	Code No		Code No		Code No
Colors	xxx	Colors	xxx	Colors	xxx
White	001	Fume	050	Pearl	100
Beige	010	Brown	096	Natural Oak	101
Metallic Silver	065	Light Brown	097	Natural Walnut	102
Dore	057	Brown / Light Brown	009	Natural Cherry	103
Green	052	Black	111	Natural Pine	105