

DORMITOR RUXANDRA

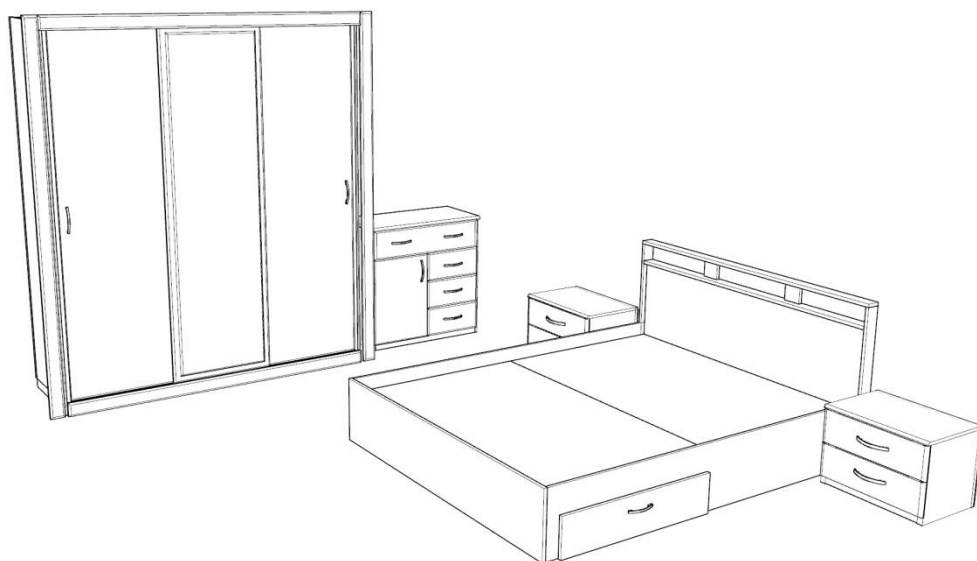

SOCUB
CONFORT PENTRU CASA TA

ATENȚIE!

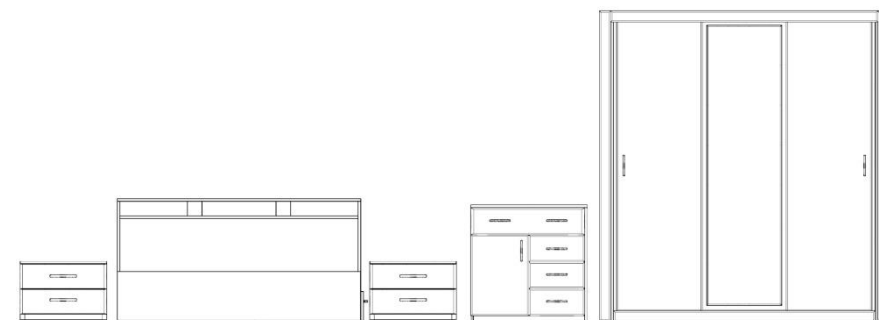







Montajul necorespunzător atrage după sine, pierderea garanției produsului.



**Acordați o atenție sporită!
Posibilitate de accidentare!**

REPERE SIFONIER

simbol	bucati	denumire
F	1	PLACA INFERIOARA DIMENSIUNI : 1968 x 600
A	2	PERETI INTERMEDIARI DIMENSIUNI : 2018 x 500
P	2	PERETI LATERALI DIMENSIUNI : 2084 x 600
X	1	PLACA SUPERIOARA DIMENSIUNI : 2000 x 600
S1	2	SOCLU / PLINTA DIMENSIUNI : 2084 x 70
S2	1	SOCLU / PLINTA DIMENSIUNI : 2108 x 70
U1	1	USA DIMENSIUNI : 1981 x 690
U2	2	USA DIMENSIUNI : 1981 x 690
HDF	2	HDF SPARE CORP DIMENSIUNI :
PX	2	POLITA FIXA DIMENSIUNI : 576 x 500
PX	1	POLITA FIXA DIMENSIUNI : 780 x 500
PM	6	POLITA MOBILA DIMENSIUNI : 576 x 500

KIT DEMONTABIL		
K		8
CONFIRMATOR 50mm		
C		00
SURUB -3.5x40mm		
S7		12
SURUB -3.5x16mm		
S3		48
CUIE		
Q		40
CEP		
Y		2
SUPPORT POLITA		
J		24
TALPA/protectie podea		
T		4
SUPPORTI BARA HAINE		
+		4

Se fixeaza **F** (placa inferioara) si **X** (placa superioara) pe **P** (pereti laterali) cu cate 2 kit demontabil **K**.

Se strang camele **K** –prin invartire in sens +
Se fixeaza **A** (placa intermediara) pe **X** (placa superioara) si **F** (placa inferioara) cu cate 2 suruburi **S7**.

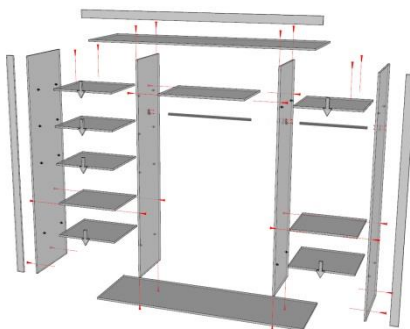

Soclu **S** se fixeaza de **P** (pereti laterali) cu 2 cepuri **Y**.

Se fixeaza **PX** (politele fixe) pe **P** (peretele lateral) si **A** (placa intermediara) cu cate 2 suruburi **S7**.

Se aduce corpul la vinclu de 90* si se fixeaza **HDF** (spate) cu **Q** (cuie).

Se fixeaza **T** (talpile) cu cate 2 suruburi **S3**.

Se monteaza **J** (butoni de polita) pe

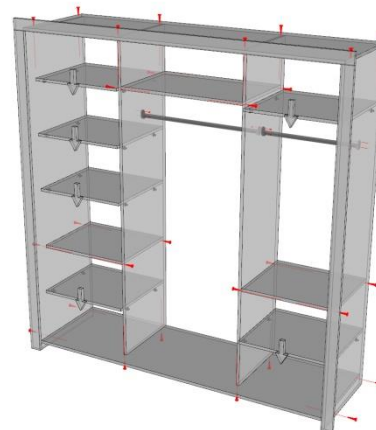

P (pereti laterali) pe care se fixeaza **PM** (polita mobila).



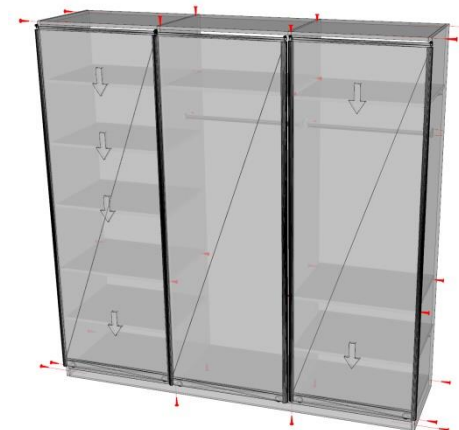

Pe **P** (peretele lateral) si pe **A** (placa intermediara) se monteaza **+** (suporti de bara de haine) pe care se fixeaza bara de haine.

Se monteaza **U** (usile) si sina de culisare.



REPERE PAT

simbol	bucati	denumire
F	1	PLACA INFERIOARA DIMENSIUNI : 1674 x 335
P	2	PERETI LATERALI DIMENSIUNI : 2000 x 335
X	1	TABLIE MARE DIMENSIUNI : 1640 x 700
L1	2	straifuri DIMENSIUNI : 818 x 70
L2	1	straifuri DIMENSIUNI : 1640 x 70
L3	1	straifuri DIMENSIUNI : 1676 x 70
FS	1	FATA SERTAR DIMENSIUNI : 850 x 200
LS	3	LATERALE SERTAR DIMENSIUNI : 703 x 120
BS	2	BISCUITI DIMENSIUNI : 100 x 100

SURUB -3.5x40mm		
S7		00
SURUB -3.5x16mm		
S3		00
CEP		
Y		00
TALPA/protectie podea		
T		00

Se fixeaza **X** (tablita de pat) de **P** (lateralele patului)
Se fixeaza **F** (placa inferioara) de **P** (lateralele patului)

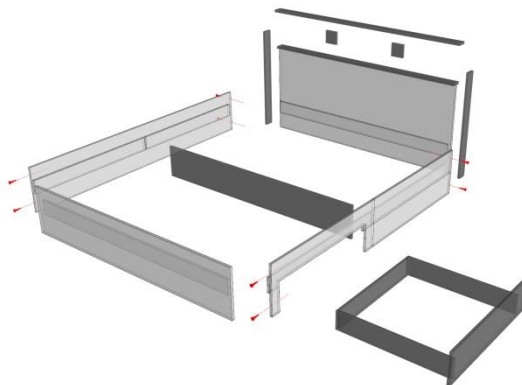



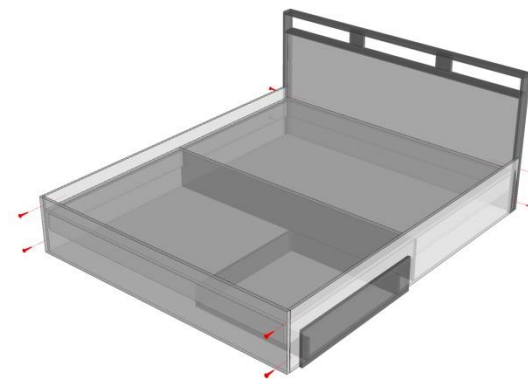



Se fixeaza **L** (lezelele) cu **X** (tablita de pat) cu suruburi.
Se aseaza placile nemelaminat e si suportii laterali pe care se pune saltea.

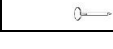

REPERE COMODA

simbol	bucati	denumire
F	1	PLACA INFERIOARA DIMENSIUNI : 768 x 405
P	2	PERETI LATERALI DIMENSIUNI : 780 x 405
X	1	PLACA SUPERIOARA DIMENSIUNI : 800 x 425
S	0	SOCLU / PLINTA DIMENSIUNI :
HDF	1	HDF SPARE CORP DIMENSIUNI :
A	1	PERETI INTERMEDIARI DIMENSIUNI : 520 x 405
U	1	USA DIMENSIUNI : 543 x 395

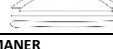
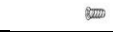
GLISIERA / SET		
G		4
KIT DEMONTABIL		
K		10
SURUB -3.5x40mm		
S7		2
SURUB -3.5x16mm		
S3		26
CUIE		
Q		20
CEP		
Y		2
TALPA/protectie podea		
T		4
MANER		
M		6
SURUB MANER		
N		12

Se fixeaza **G** (glisierile) pe **P** (peretii laterali) cu suruburi **S3**.
Se fixeaza **P** (pereti laterali) pe **F** (placa inferioara) si pe **X** (placa superioara) cu cate 2 kit demontabil **K**.
Se fixeaza **A** (placa intermediara) pe **X** (placa superioara) si **F** (placa inferioara) cu cate 2 suruburi **S7**.

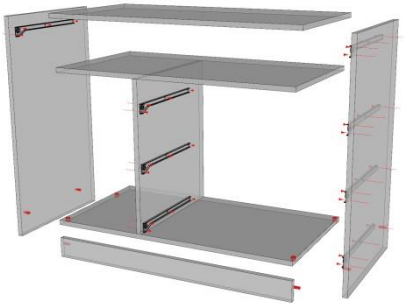

Se strang camele **K** –prin invartire in sens +
Soclu **S** se fixeaza de **P** (pereti laterali) cu 2 cepuri **Y**.
Se fixeaza straiul cu cate 2 kit demontabil **K**.

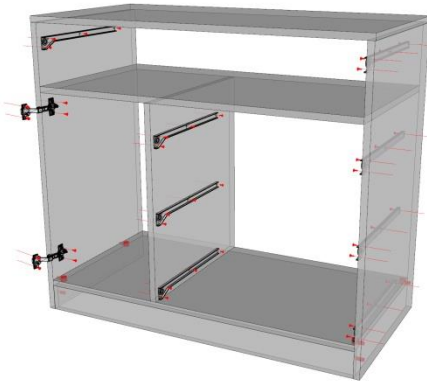

Se aduce corpul la vinclu de 90° si se fixeaza **HDF** (spate) cu **Q** (cuiie).
Se fixeaza **T** (talpile) cu cate 2 suruburi **S3**.
Se monteaza **U** (usa) folosind **B** (balamale) cu suruburi **S3**.
Se monteaza **M** (manerul) usi folosind cate 2 suruburi **N**.





SERTAR COMODA

FS	3	FATA SERTAR DIMENSIUNI : 395 x 180
FS	1	FATA SERTAR DIMENSIUNI : 795 x 180
LS	8	LATERALE SERTAR DIMENSIUNI : 400 x 120
CS	3	CAPAT SERTAR DIMENSIUNI : 319 x 120
CS	1	CAPAT SERTAR DIMENSIUNI : 711 x 120
HS	4	HDF SERTAR DIMENSIUNI :

MONTAJUL SERTARELOR

Se fixeaza **LS** (lateralele de sertar) cu **CS** (capat de sertar) prin 4 suruburi **S7**
Se fixeaza **LS** (lateralele de sertar) cu **FS** (fata de sertar) prin 2 kit demontabil **K**. Se strang camele **K** –prin invartire in sens +
Se fixeaza **G** (glisierile) de **LS** cu cate 2 suruburi **S3**
Se fixeaza **M** (maner) cu 2 suruburi **N**
Se aduce sertarul la vinclu de 90° si se fixeaza fundul de sertar **HS** cu **Q** (cuiie)

KIT DEMONTABIL		
K		4
SURUB -3.5x40mm		
S7		4
SURUB -3.5x16mm		
S3		6

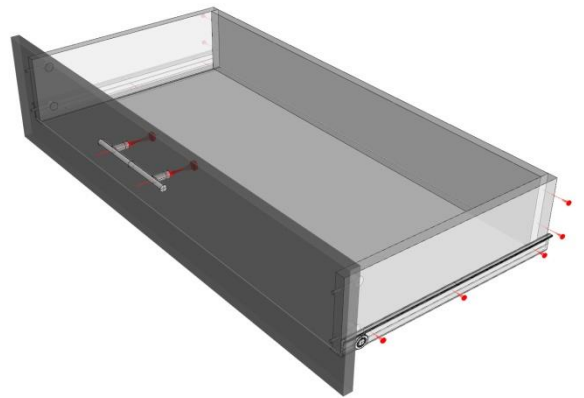
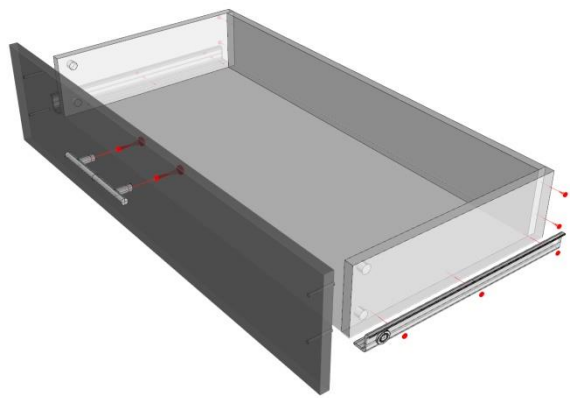

REPERE NOPTIERA

simbol	bucati	denumire
F	1	PLACA INFERIOARA DIMENSIUNI : 380 x 368
P2	2	PERETI LATERALI DIMENSIUNI : 380 x 380
X	1	PLACA SUPERIOARA DIMENSIUNI : 400 x 400
S	1	SOCLU / PLINTA DIMENSIUNI :
HDF	1	HDF SPARE CORP DIMENSIUNI :

GLISIERA / SET		
G		2
KIT DEMONTABIL		
K		10
SURUB -3.5x40mm		
S7		2
SURUB -3.5x16mm		
S3		14
CUIE		
Q		20
CEP		
Y		8
TALPA/protectie podea		
T		4
MANER		
M		2
SURUB MANER		
N		4

Se fixeaza **G** (glisierile) pe **P** (peretii laterali) cu suruburi **S3**.
Se fixeaza **P** (pereti laterali) pe **F** (placa inferioara) si pe **X** (placa superioara) cu cate 2 kit demontabil **K**.

Se strang camele **K** –prin invartire in sens + Soclul **S** se fixeaza de **P** (pereti laterali) cu 2 cepuri **Y**.
Se fixeaza straiful cu cu cate 2 kit demontabil **K**.

Se aduce corpul la vinclu de 90* si se fixeaza **HDF** (spate) cu **Q** (cuiie).
Se fixeaza **T** (talpile) cu cute 2 suruburi **S3**.

SERTAR NOPTIERA

FS	2	FATA SERTAR DIMENSIUNI : 395 x 160
LS	4	LATERALE SERTAR DIMENSIUNI : 320 x 120
CS	1	CAPAT SERTAR DIMENSIUNI : 311 x 120
HS	1	HDF SERTAR DIMENSIUNI :

KIT DEMONTABIL		
K		2
SURUB -3.5x40mm		
S7		2
SURUB -3.5x16mm		
S3		6

MONTAJUL SERTARELOR

Se fixeaza **LS** (lateralele de sertar) cu **CS** (capat de sertar) prin 4 suruburi **S7**
Se fixeaza **LS** (lateralele de sertar) cu **FS** (fata de sertar) prin 2 kit demontabil **K**. Se strang camele **K** –prin invartire in sens +
Se fixeaza **G** (glisierile) de **LS** cu cate 2 suruburi **S3**
Se fixeaza **M** (maner) cu 2 suruburi **N**
Se aduce sertarul la vinclu de 90* si se fixeaza fundul de sertar **HS** cu **Q** (cuiie)

