













Va rugam, dupa ce deschideti coletul, sa verificati daca sunt toate accesoriile de feronerie, precum si existenta numarului de piese mentionate in schita de montaj. In cazul constatarii lipsurilor (feronerie, piese) sau defectiunilor va rugam sa anuntati personalul Arabesque Home in termen de 24 ore de la achizitionarea produsului, comunicand lipsurile si defectiunile constatate si numarul stampilei C.T.C. de pe ambalaj. In cazul necomunicarii defectiunilor sau lipsurilor constatate in termenul de mai sus, SC LUX-ARTIM SRL nu-si asuma raspunderea pentru eventualele neconformitati. Va multumim pentru intelegere.

ETAJERE
ETAJERA E1 SONOMA-WENGE 600x250x1410
VERSIUNEA: 02/30.08.2018

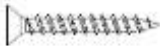

 X1
 45 min



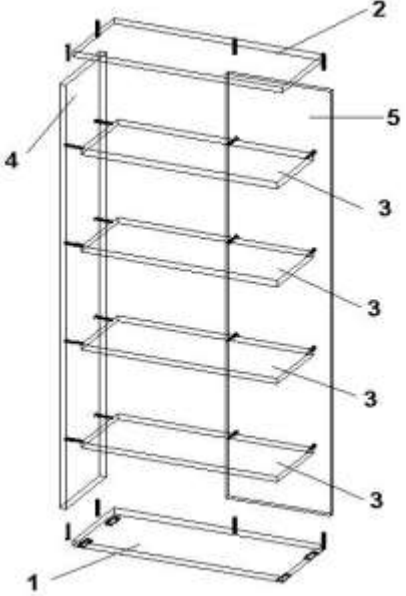

	
A - Eurosurub 7x50 - 24buc	
	
B - Holtzsurub 4x18 - 8buc	
	
C - Picior plat plastic - 4buc	
	
D - Cheie imbus 4mm - 1buc	
	
E - Capacele autoadezive sonoma -8buc	



1 - Placa fund
2 - Placa capac
3 - Polite - 4buc
4 - Laterala
5 - Placa spate

Instructiuni de asamblare etajera:
 1 - Se fixeaza placa fund 1 de laterala 4 si placa capac 2 cu eurosuruburi A
 2 - Se fixeaza placa spate 5 de placa fund 1 si placa capac 2 cu eurosuruburi A
 3 - Se fixeaza politele 3 de laterala 4 si placa spate 5 cu eurosuruburi A
 4 - Se prind pe placa fund 1 cele 4buc picior plat plastic cu holtzsuruburi B.
 5 - Se aplica capacele autoadezive pe eurosuruburile vizibile