

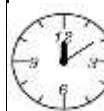

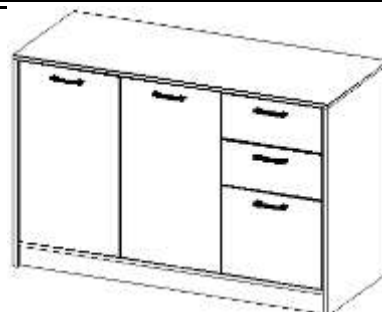









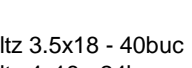

Va rugam, dupa ce deschideti coletul, sa verificati daca sunt toate accesoriile de feronerie, precum si existenta numarului de piese mentionate in schita de montaj. In cazul constatarii lipsurilor (feronerie, piese) sau defectiunilor va rugam sa anuntati personalul Arabesque Home in termen de 24 ore de la achizitionarea produsului, comunicand lipsurile si defectiunile constatate si numarul stampilei C.T.C. de pe ambalaj. In cazul necomunicarii defectiunilor sau lipsurilor constatate in termenul de mai sus, SC LUX-ARTIM SRL nu-si asuma raspunderea pentru eventualele neconformitati. Va multumim pentru intelegere.

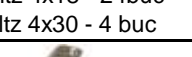
MIC MOBILIER
COMODA 3USI 2SERTARE 1200X500X1000 (MM12W/MM12S/MM12M)
VERSIUNEA: 03/13.11.2018

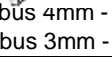

 A - Eurosurub 7x50 - 3buc	 I - Set Glisiere 450 - 2buc
 B - Eurosurub 5x50 - 16buc	 J - Cuie Hdf 2x20- 54buc
 C - Holtz 3.5x18 - 40buc	 K - Maner satin - 5buc
 D - Holtz 4x18 - 24buc	 L - Surub maner 4x25 - 6buc
 E - Holtz 4x30 - 4 buc	 M - Surub maner 4x40 - 4buc
 F - Balama semiaplicata - 2buc	 N - Cheie imbus 4mm - 1buc
 G - Balama BUI - 4buc	 O - Cheie imbus 3mm - 1buc
 H - Excentric 15x32 - 12buc	 P - suport polita - 4buc

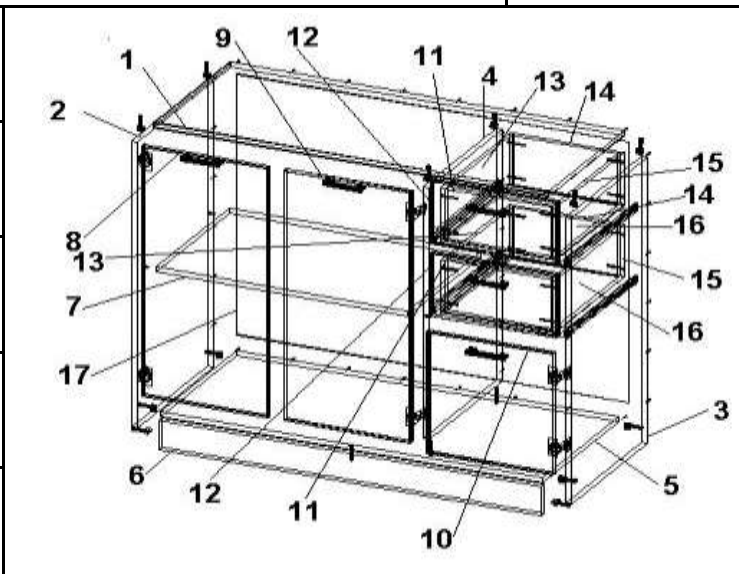

1 - Placa capac	9 - Usa
2 - Laterala	10 - Usa
3 - Laterala	11 - Fata interior sertar
4 - Laterala	12 - Fata sertar
5 - Placa fund	13 - Laterala sertar
6 - Plinta	14 - Spate sertar
7 - Raft	15 - Laterala sertar
8 - Usa	16 - Fund sertar

1. Se monteaza pe capacul 1 bucele excentricilor H.
2. Pe lateralele 3 si 4 se prind cu holtzsuruburi C glisierile I in gaurile punctate.
3. Se monteaza lateralele 2 si 3 pe fundul 5 si plinta 6 folosind eurosuruburi A.
4. Se monteaza laterala 4 pe fundul 5 cu ajutorul eurosuruburilor A.
5. Se monteaza capacul 1 pe lateralele 2, 3 si 4 cu ajutorul excentricilor H.
6. Se fixeaza cu cuie Hdf J spatelul Hdf 17 de capacul 1, lateralele 2 si 3 si fundul 5
7. Se prind lateralele sertar 13 si 15 de piesele interior sertar 11 si spatelul sertar 14 cu ajutorul eurosuruburilor B
8. Se prinde fund sertar 16 de componentele sertar montate anterior, folosind cuie Hdf J.
9. Se monteaza glisierile I pe lateralele sertar 13 si 15, pe partea inferioara folosind holtzsuruburi C
10. Se monteaza balamalele F pe usa 9 si pe laterala 4 cu ajutorul holtzsuruburilor D.
11. Se monteaza balamalele G pe usile 8 si 10 si pe lateralele 2 respectiv 3 cu ajutorul holtzsuruburilor D.
12. Se monteaza manerele pe usile 8, 9 si 10 folosind suruburi maner L.
13. Se monteaza manerele K pe fetele de sertar 12 si se prind de fetele interior sertar 11 cu ajutorul suruburilor de maner M.
14. Se fixeaza fetele de sertar 12 de sertare folosind cate doua holtzsuruburi E.
15. Se aseaza polita 7 pe suportii de polita P introdusi in lateralele 2 si 4.
16. Se aseaza sertarele pe sinele montate pe lateralele 2 si 3.