

BUCATARIE 3000mm

MARINA

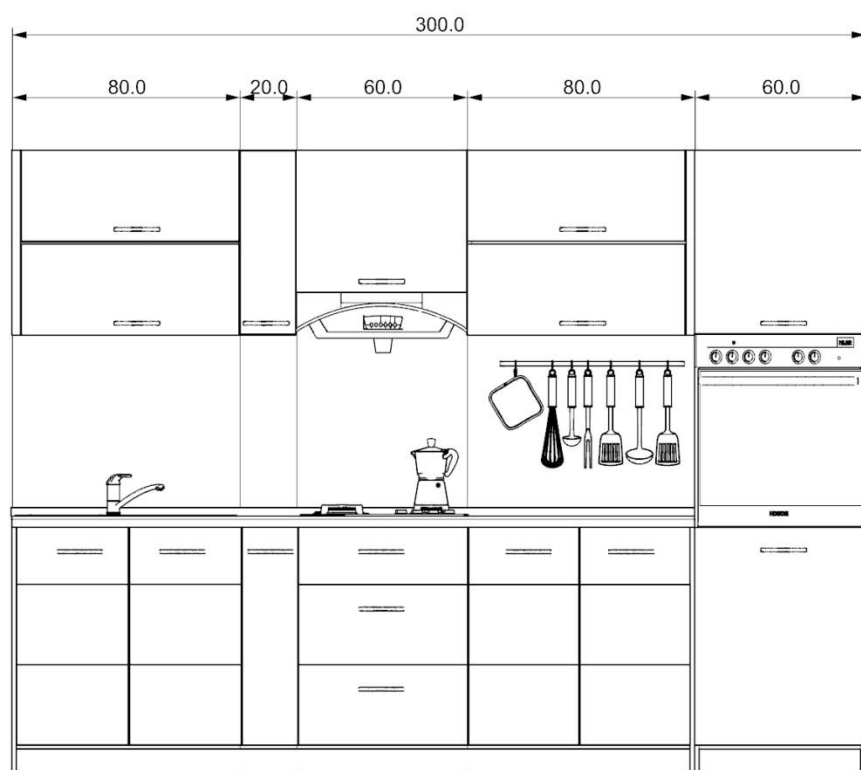

SOCUB
CONFORT PENTRU CASA TA

ATENȚIE!









Montajul necorespunzător atrage după sine, pierderea garanției produsului.

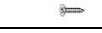

Acordați o atenție sporită!
Posibilitate de accidentare!

REPERE CORP INFERIOR- 100 cm

simbol	bucati	denumire
F	1	PLACA INFERIOARA DIMENSIUNI : 984 X 450
Ps	1	PERETE LATERAL STANGA DIMENSIUNI : 750 X 450
A	1	PERETE INTERMEDIAR DIMENSIUNI : 734 X 450
Pd	1	PERETE LATERAL DREAPTA DIMENSIUNI : 860 X 450
L	2	LEZENE DIMENSIUNI : 968 X 70
HDF	1	HDF SPARE CORP DIMENSIUNI : 995 x 760
U1	2	USA DIMENSIUNI : 388 x 184
U2	2	USA DIMENSIUNI : 388 x 284
U3	2	USA DIMENSIUNI : 388 x 284
U4	1	USA DIMENSIUNI : 195 x 755

KIT DEMONTABIL		
K		2
CONFIRMATOR 50mm		
C		10
SURUB -3.5x40mm		
S7		4
SURUB -3.5x16mm		
S3		36
CUIE		
Q		40
BALAMA		
B		6
MANER		
M		3
SURUB MANER		
N		6
TALPA/protectie podea		
T		2
PICIOR PLASTIC		
T		2

Se fixeaza **G** (glisierile) pe **P** (peretele lateral) si pe **A** (peretele intermediar) cu suruburi **S3**.
Se fixeaza **F** (placa inferioara) pe **P** (peretele lateral dreapta) cu cate 2 demontabili **K**.
Se strang camele **K** -prin invartire in sens +
Se fixeaza **Pd** (peretele lateral stanga) si **A** (peretele intermediar) pe **F** (placa inferioara) cu cate 2 configuratoare **C**.

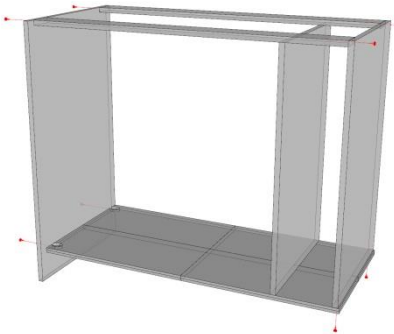



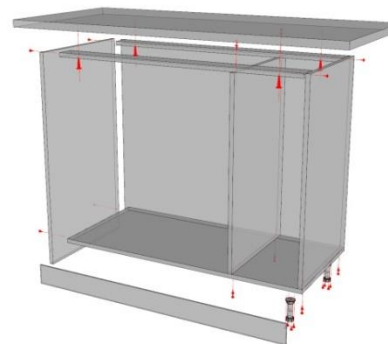



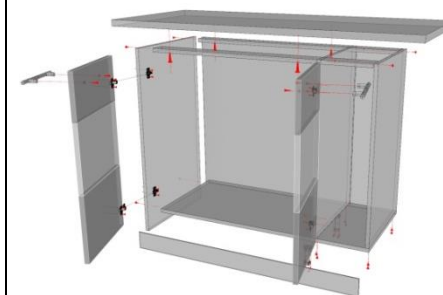

Se fixeaza **L** (lezenele) pe **P** (pereti laterali) si **A** (peretele intermediar) cu cate 2 configuratoare **C**.
Se aduce corpul la vinclu de 90* si se fixeaza **HDF** (spate) cu **Q** (cuie).
Se fixeaza **T** (picioarele) cu cate 4 suruburi **S3**.
Se fixeaza **X** (blatul) pe **L** (lezene) cu suruburi **S7**

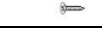
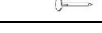

Se fixeaza **S** (plinta) de **T** (picioare).
Se monteaza **U** (usile) folosind **B** (balamale) cu suruburi **S3**.
Usaile sunt formate din **U1 / U2 / U3 / U4**
Se monteaza **M** (manerul) usi folosind cate 2 suruburi **N** pentru fiecare maner

**REPERE CORP INFERIOR
CU 2 USI - 80 cm STANGA**

simbol	bucati	denumire
F	1	PLACA INFERIOARA DIMENSIUNI : 784 X 450
Ps	1	PERETE LATERAL STANGA DIMENSIUNI : 860 X 480
Pd	1	PERETE LATERAL DREAPTA DIMENSIUNI : 750 X 450
L	2	LEZENE DIMENSIUNI : 768 X 70
HDF	1	HDF SPARE CORP DIMENSIUNI : 795 x 760
U1	2	USA DIMENSIUNI : 388 x 184
U2	2	USA DIMENSIUNI : 388 x 284
U3	2	USA DIMENSIUNI : 388 x 284
X	1	BALT TERMOREZISTENT DIMENSIUNI : 2000 x 600
S	1	SOCLU / PLINTA DIMENSIUNI : 2000 x 100

KIT DEMONTABIL		
K		2
CONFIRMATOR 50mm		
C		6
SURUB -3.5x40mm		
S7		4
SURUB -3.5x16mm		
S3		24
CUIE		
Q		30
BALAMA		
B		4
MANER		
M		2
SURUB MANER		
N		4
TALPA/protectie podea		
T		2
PICIOR PLASTIC		
T		2

Se fixeaza **F** (placa inferioara) pe **P** (peretele lateral stanga) cu cate 2 demontabili **K**.
Se strang camele **K** -prin invartire in sens +
Se fixeaza **P** (peretele latalar dreapta) pe **F** (placa inferioara) cu cate 2 configuratoare **C**.
Se fixeaza **L** (lezenele) pe **P** (pereti laterali) cu cate 2 configuratoare **C**.

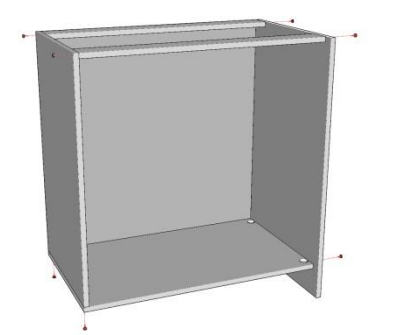

Se aduce corpul la vinclu de 90* si se fixeaza **HDF** (spate) cu **Q** (cuie).
Se fixeaza **T** (picioarele) cu cate 4 suruburi **S3**.
Se fixeaza **X** (blatul) pe **L** (lezene) cu suruburi **S7**
Se fixeaza **S** (plinta) de **T** (picioare).

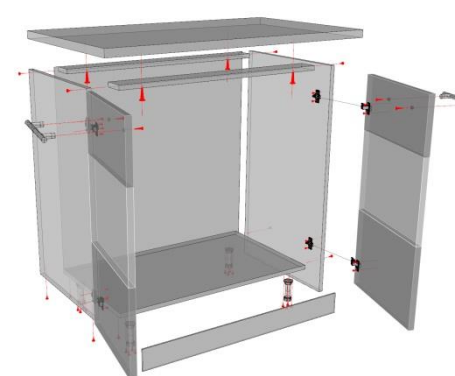









Se monteaza **U** (usile) folosind **B** (balamale) cu suruburi **S3**. Usaile sunt formate din **U1 / U2 / U3**.
Se monteaza **M** (manerale) usilor folosind 2 suruburi **N** pentru fiecare maner.



REPERE CORP INFERIOR - 60 cm

simbol	bucati	denumire
F	1	PLACA INFERIOARA DIMENSIUNI : 600 X 450
P	2	PERETI LATERALI DIMENSIUNI : 750 X 450
L	2	LEZENE DIMENSIUNI : 568 X 70

CONFIRMATOR 50mm		
C		8
SURUB -3.5x40mm		
S7		4
SURUB -3.5x16mm		
S3		34
CUIE		
Q		30
GLISIERA/ SET		
G		3
PICIOR PLASTIC		
T		4
MANER		
M		3
SURUB MANER		
N		6

Se fixeaza **G** (glisierile) pe **P** (pereti laterali) cu suruburi **S3**.

Se fixeaza **P** (pereti laterali) pe **F** (placa inferioara) cu cate 2 configuratoare **C**.

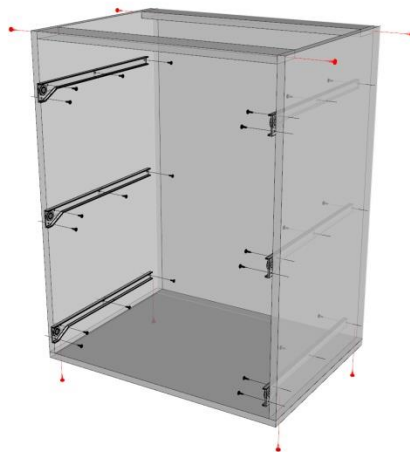

Se fixeaza **L** (lezele) pe **P** (pereti laterali) cu cate 2 configuratoare **C**.

Se aduce corpul la vinclu de 90* si se fixeaza **HDF** (spate) cu **Q** (cuiie).

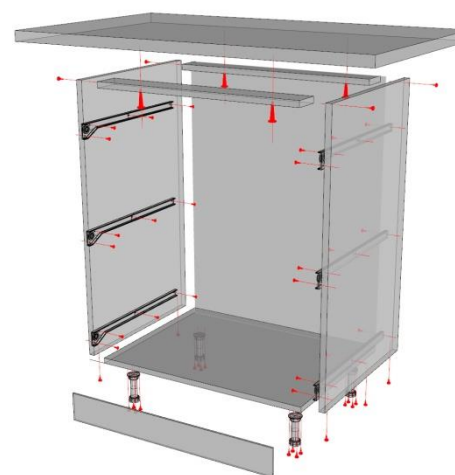

Se fixeaza **T** (picioarele) cu cute 4 suruburi **S3**.

Se fixeaza **X** (blatul) pe **L** (lezene) cu suruburi **S7**

Se fixeaza **S** (plinta) de **T** (picioare).



SERTAR 1

FS	1	FATA SERTAR DIMENSIUNI : 595 x 184
LS	2	LATERALE SERTAR DIMENSIUNI : 400 X 120
CS	1	CAPAT SERTAR DIMENSIUNI : 511 X 120
HS	1	HDF SERTAR DIMENSIUNI : 540 X 400

SERTAR 2 - 3

FS	2	FATA SERTAR DIMENSIUNI : 595 x 284
LS	4	LATERALE SERTAR DIMENSIUNI : 400 X 150
CS	2	CAPAT SERTAR DIMENSIUNI : 511 X 150
HS	2	HDF SERTAR DIMENSIUNI : 540 X 400

MONTAJUL SERTARELOR



Se fixeaza **LS** (lateralele de sertar) cu **CS** (capat de sertar) prin 4 suruburi **S7**

Se fixeaza **LS** (lateralele de sertar) cu **FS** (fata de sertar) prin 2 kit demontabil **K**. Se strang camele **K** -prin invartire in sens +

Se fixeaza **G** (glisierile) de **LS** cu cate 2 suruburi **S3**

Se fixeaza **M** (maner) cu 2 suruburi **M**

Se aduce sertarul la vinclu de 90* si se fixeaza fundul de sertar **HS** cu **Q** (cuiie)

KIT DEMONTABIL		
K		6
SURUB -3.5x40mm		
S7		12
SURUB -3.5x16mm		
S3		12

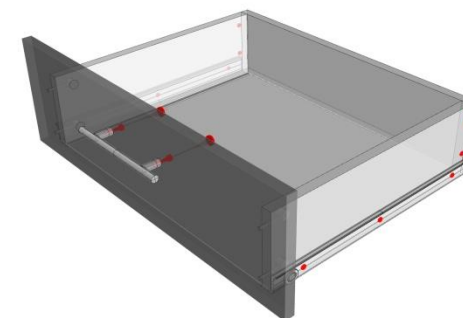
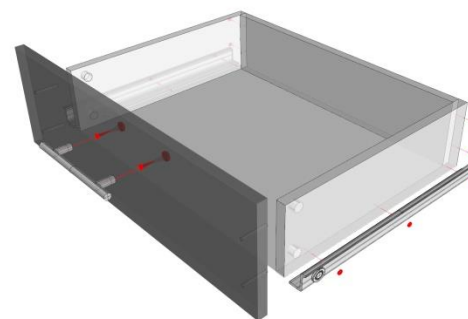

REPERE CORP SUPERIOR
- 100 cm

simbol	bucati	denumire
F	1	PLACA INFERIOARA DIMENSIUNI : 984 x 335
A	1	PLACA INTERMEDIARA DIMENSIUNI : 968 X 335
Pd	1	PERETE LATERAL DREAPTA DIMENSIUNI : 618 x 335
Ps	1	PERETE LATERAL STANGA DIMENSIUNI : 650 x 354
A	1	PERETE INTERMEDIAR DIMENSIUNI : 650 x 354
X	1	PLACA SUPERIOARA DIMENSIUNI : 984 x 335
HDF	1	HDF SPARE CORP DIMENSIUNI : 995 X 645
U	2	USA DIMENSIUNI : 778 x 320
U	1	USA DIMENSIUNI : 645 x 195

KIT DEMONTABIL		
K		8
CONFIRMATOR 50mm		
C		4
SURUB -3.5x16mm		
S3		32
CUIE		
Q		30
SURUB MANER		
N		6
MANER		
M		3
COLTAR + PROTECTIE PVC		
V		2
PISTON		
R		4
BALAMA		
B		6

Se fixeaza **P**(pereti laterali) pe **F**(placa inferioara) si de **X**(placa superioara) cu cate 2 demontabili **K**.
Se strang camele **K** –prin invartire in sens +
Se fixeaza **A**(placa intermediara) pe **P**(pereti laterali) cu cate 2 configuratoare **C**.

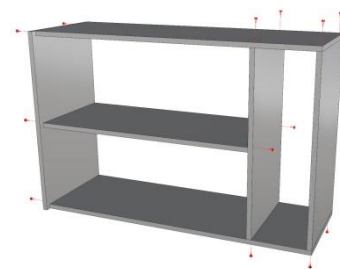

Se aduce corpul la vinclu de 90* si se fixeaza **HDF** (spate) cu **Q** (cuie).
Se fixeaza corpul (in perete) folosind coltarele **V**.
Se recomanda montarea corpului la acest pas, pentru a evita ingreunarea acestuia cu usile si pentru un mai bun acces la coltare.

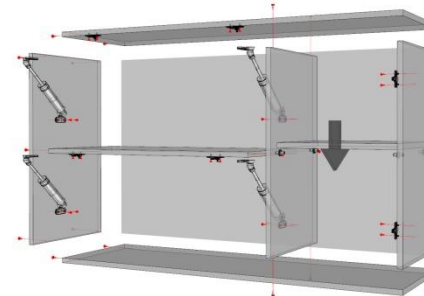

Se monteaza **U** (usile) folosind **B** (balamale) cu suruburi **S3**.
Se monteaza **R** (pistonol) cu cate 4 suruburi **S3**.
Se monteaza **M** (manerele) usilor folosind 2 suruburi **N** pentru fiecare maner.

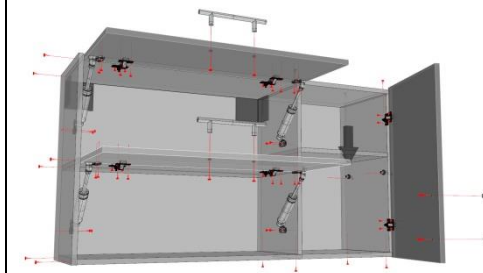

REPERE CORP SUPERIOR
CU 2 USI - 60 cm DREAPTA

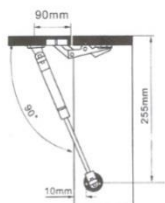
simbol	bucati	denumire
F	1	PLACA INFERIOARA DIMENSIUNI : 584 x 335
A	1	PLACA INTERMEDIARA DIMENSIUNI : 568 X 335
Ps	1	PERETE LATERAL STANGA DIMENSIUNI : 618 x 335
Pd	1	PERETE LATERAL DREAPTA DIMENSIUNI : 650 x 354
X	1	PLACA SUPERIOARA DIMENSIUNI : 584 x 335
HDF	1	HDF SPARE CORP DIMENSIUNI : 595 X 645
U	2	USA DIMENSIUNI : 578 x 320

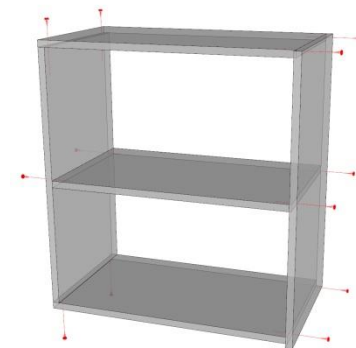

KIT DEMONTABIL		
K		8
CONFIRMATOR 50mm		
C		4
SURUB -3.5x16mm		
S3		32
CUIE		
Q		30
SURUB MANER		
N		4
MANER		
M		2
COLTAR + PROTECTIE PVC		
V		2
PISTON		
R		4
BALAMA		
B		4

Se fixeaza **P**(pereti laterali) pe **F**(placa inferioara) si de **X**(placa superioara) cu cate 2 demontabili **K**.
Se strang camele **K** –prin invartire in sens +
Se fixeaza **A**(placa intermediara) pe **P**(pereti laterali) cu cate 2 configuratoare **C**.



Se aduce corpul la vinclu de 90* si se fixeaza **HDF** (spate) cu **Q** (cuie).
Se fixeaza corpul (in perete) folosind coltarele **V**.
Se recomanda montarea corpului la acest pas, pentru a evita ingreunarea acestuia cu usile si pentru un mai bun acces la coltare.

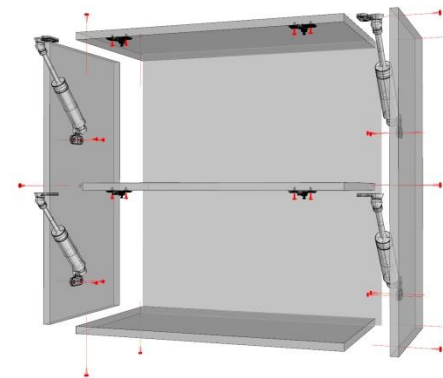



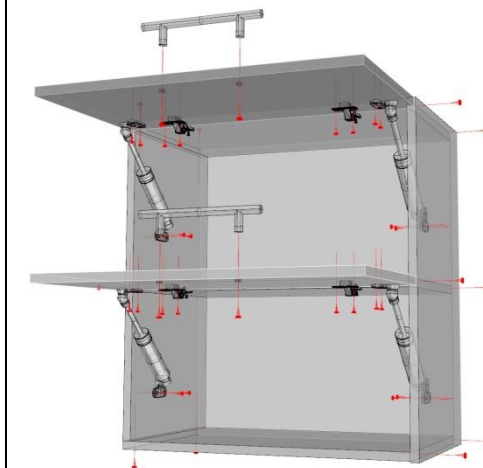





Se monteaza **U** (usile) folosind **B** (balamale) cu suruburi **S3**.
Se monteaza **R** (pistonol) cu cate 4 suruburi **S3**.
Se monteaza **M** (manerele) usilor folosind 2 suruburi **N** pentru fiecare maner.



REPERE CORP SUPERIOR – 60 cm

simbol	bucati	denumire
F	1	PLACA INFERIOARA DIMENSIUNI : 600 X 335
X	1	PLACA SUPERIOARA DIMENSIUNI : 600 X 335
P	2	PERETI LATERALI DIMENSIUNI : 568 X 335
PM	1	POLITA MOBILA DIMENSIUNI : 568 X 310
HDF	1	HDF SPARE CORP DIMENSIUNI : 595 X 645
U	1	USA DIMENSIUNI : 595 x 595

CONFIRMATOR 50mm		
C		8
SURUB -3.5x16mm		
S3		8
CUIE		
Q		20
COLTAR + PROTECTIE PVC		
V		2
SUPPORT POLITA		
J		4
BALAMA		
B		2
MANER		
M		1
SURUB MANER		
N		2

Se fixeaza **P** (pereti laterali) pe **F** (placa inferioara) si de **X** (placa superioara) cu cate 2 configuratoare **C**.
Se aduce corpul la vinclu de 90* si se fixeaza **HDF** (spate) cu **Q** (cuie).

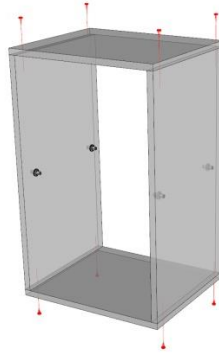

Se fixeaza corpul (in perete) folosind coltarele **V**.
Se recomanda montarea corpului la acest pas, pentru a evita ingreunarea acestuia cu usile si pentru un mai bun acces la coltare.





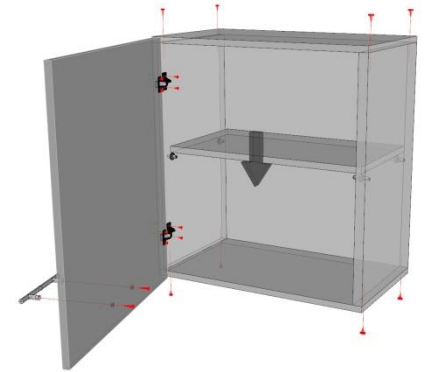





Se monteaza **J** (butoni de polita) pe **P** (pereti laterali) pe care se fixeaza **PM** (polita mobila)
Se monteaza **U** (usa) folosind **B** (balamale) cu suruburi **S3**.
Se monteaza **M** (manul) usi folosind 2 suruburi **N**



REPERE CORP TURN- 60 cm

simbol	bucati	denumire
F	1	PLACA INFERIOARA DIMENSIUNI : 584 X 450
P	2	PERETE LATERALI DIMENSIUNI :
X	1	PLACA SUPERIOARA DIMENSIUNI : 584 X 450
PM	4	POLITA MOBILA DIMENSIUNI : 584 X 440

KIT DEMONTABIL		
K		8
CONFIRMATOR 50mm		
C		8
SURUB -3.5x40mm		
S7		4
SURUB -3.5x16mm		
S3		36
CUIE		
Q		20
MANER		
M		2
SURUB MANER		
N		4
PICIOR PLASTIC		
T		4
SUPPORT POLITA		
J		12

Se fixeaza **F** (placa inferioara) pe **P** (pereti laterali) cu cate 2 demontabili **K**.
Se fixeaza **X** (placa superioara) pe **P** (pereti laterali) cu cate 2 demontabili **K**.
Se strang camele **K** –prin invartire in sens +
Se aduce corpul la vinclu de 90* si se fixeaza **HDF** (spate) cu **Q** (cuie).
Se fixeaza **T** (picioarele) cu cate 4 suruburi **S3**.
Se monteaza **J** (butoni de polita) pe **P** (pereti laterali) pe care se fixeaza **PM** (polita mobila)
Se fixeaza **S** (plinta) de **T** (picioare).
Se monteaza **U** (usile) folosind **B** (balamale) cu suruburi **S3**.
Se monteaza **M** (manerul) usi folosind cate 2 suruburi **N** pentru fiecare maner

