

Diametrul cupei metalice - 26 mm; Poziționarea găurilor: 38 x 8 mm

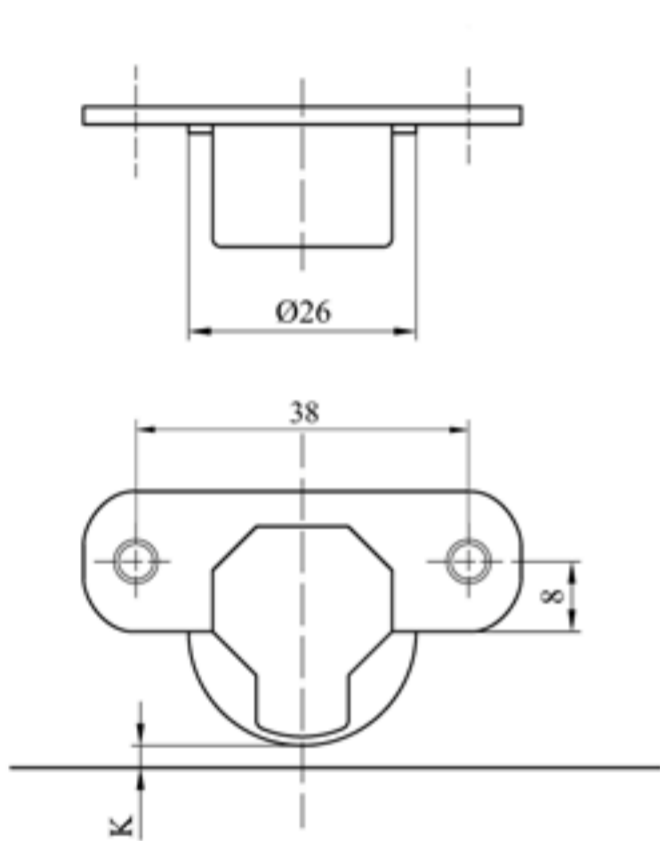

Prindere cu holz-șuruburi

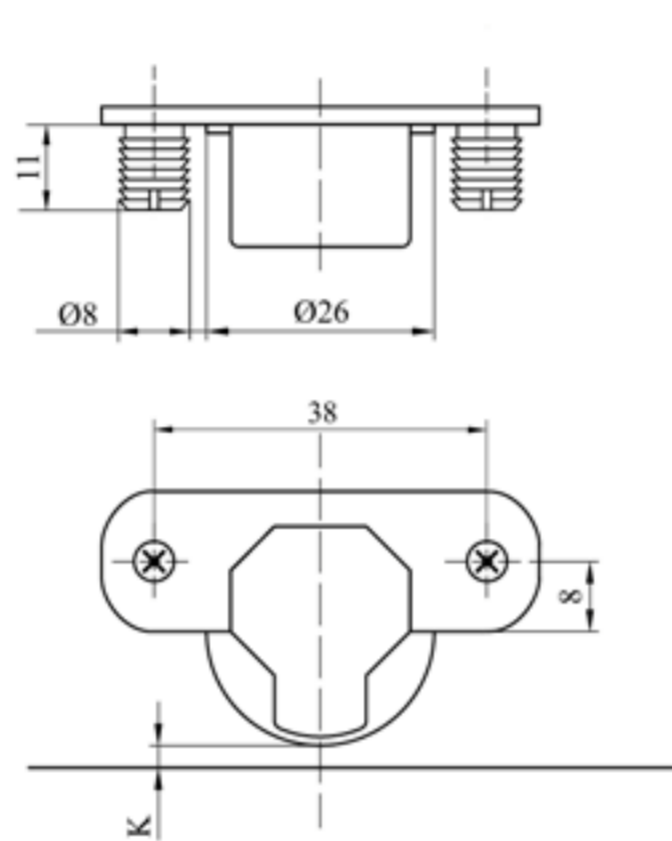

Prindere cu dibluri

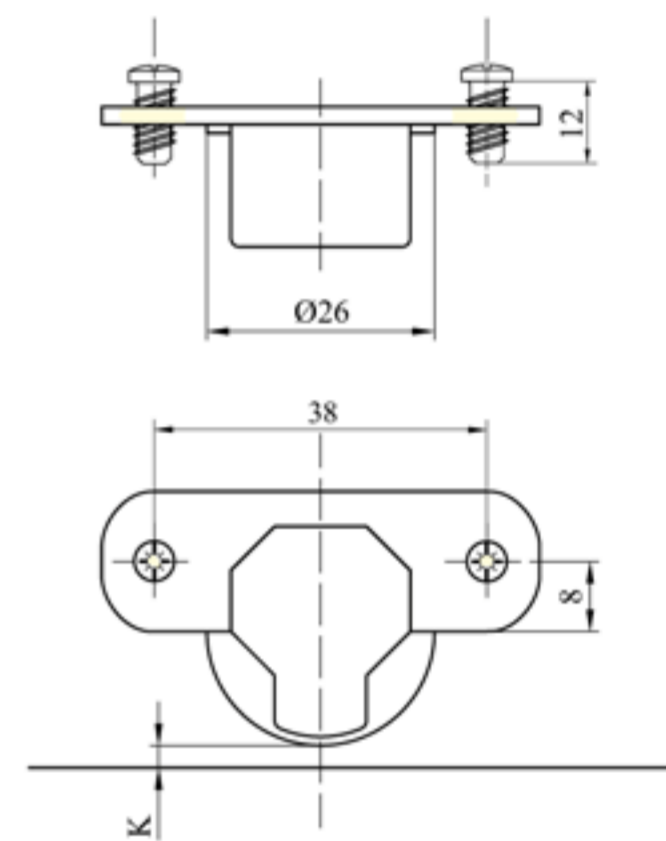

Prindere cu euroșuruburi