

PRODUCT DATASHEET

LED BULB FA-7W/GU10/840L

Consumer Products LED Bulb GU10 | LED lamps, classic bulb shape

AREAS OF APPLICATION

- Domestic applications
- General illumination
- Outdoor applications only in suitable luminaires



PRODUCT BENEFITS

- Low energy consumption
- Easy replacement of classic lamps thanks to compact design
- Instant 100 % light, no warm-up time
- Poly covered aluminium housing with better heating diffusion
- Built-in constant current driver better stability of usage

PRODUCT FEATURES

- LED alternative to conventional lamps
- Mercury-free lamps



TECHNICAL DATA

Electrical data

Rated wattage	7.00 W
Nominal wattage	7.00 W
Nominal voltage	185-240VAC
Operating frequency	50...60 Hz
Power factor λ	> 0.50
Claimed equiv. conventional lamp power	60 W

Photometrical data

Rated luminous flux	600 lm
Light color (designation)	Natural White
Color temperature	4000 K
Luminous flux	600 lm
Color rendering index Ra	≥ 80
Standard deviation of color matching	≤ 6 sdc
Nominal luminous flux	600 lm
Rated color temperature	4000 K
Color rendering index Ra	≥ 80

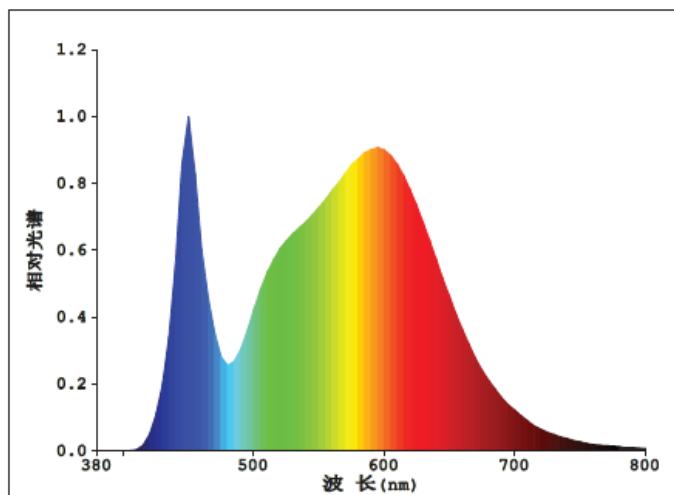

Light technical data

Starting time	< 0.5 s
Beam angle	36°

Dimensions & weight

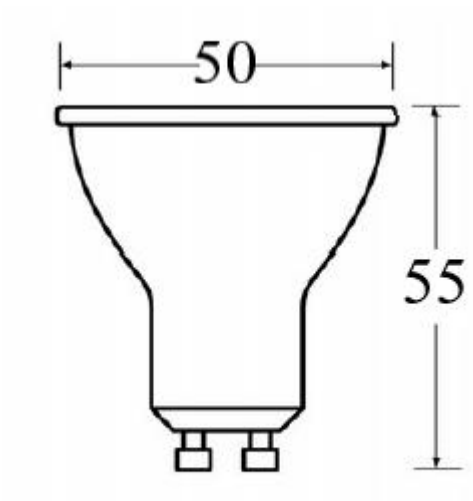

Overall length	55.0 mm
Diameter	50.0 mm
Length	55.0 mm

Lifespan

Nominal lamp life time	25000 h
Rated lamp life time	25000 h
Number of switching cycles	15000
Warranty	2 years

Capabilities

Dimmable	No
-----------------	----

Temperatures & operating conditions

Ambient temperature range	-20...+40 °C
Maximum temperature at test point	98 °C

Additional product data

Base (standard designation)	GU10
Mercury-free	Yes
Design / version	frosted
Driver type	IC
Product remark	All technical parameters apply to the entire lamp/Due to the complex production process for light-emitting diodes, the typical values shown for the technical LED parameters are purely statistical values that do not necessarily match the actual technical parameters of each individual product, which can vary from the typical value
Mercury content	0.0 mg
Standards	CE/CCC

Order code/Name

Order code/Name	FA2664 LED BULB FA-7W/GU10/840L
------------------------	---------------------------------

LOGISTICAL DATA

Product code	Packaging unit (Pieces/Unit)	Dimensions (length x width x height)	Gross weight	Volume
FA2664	Folding carton box 1	50 mm x 50 mm x 56 mm	32.00 g	0.14 dm ³
FA2664	Shipping carton box 100	570 mm x 290 mm x 175 mm	3200.00 g	0.029 m ³

The mentioned product code describes the smallest quantity unit which can be ordered. One shipping unit can contain one or more single products. When placing an order, for the quantity please enter single or multiples of a shipping

REFERENCES / LINKS

For further products and actual information concerning LED lamps see www.fucida.eu

For Guarantee see www.fucida.eu

DISCLAIMER

Subject to change without notice. Errors and omission excepted.

