

PHILIPS

Ledinaire încastat

RC060B

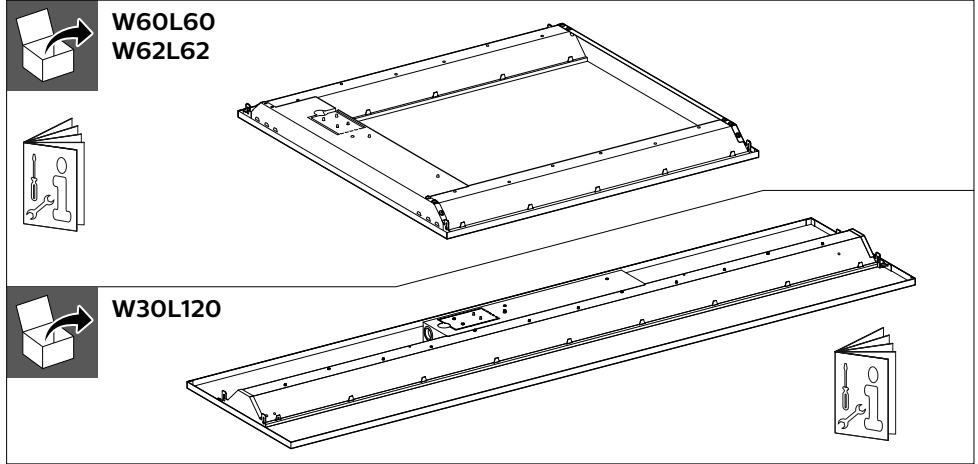

50Hz
60Hz

220V
240V

DURATA DE VIAȚĂ
L70B50
30 mii ore

IP20

IK03

Max.
40 °C
Min.
10 °C

FIR
INCANDESCENT
650 °C



	Flux luminos sistem	CCT	Balast	P(W)	Dimensiuni în mm			kg
					A	B	C	
RC060B LED32S/840 PSU W60L60		4000K			597	597	579	2.76
RC060B LED32S/830 PSU W60L60		3000K						
RC062B LED32S/840 PSU W62L62	3200lm	4000K	PSU	36	622	622	579	2.96
RC060B LED32S/840 PSU W30L120		4000K			297	1197	1179	2.50
RC060B LED32S/830 PSU W30L120		3000K						

**W60L60
W62L62**

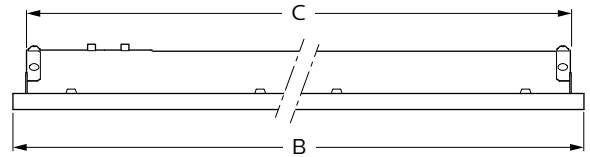
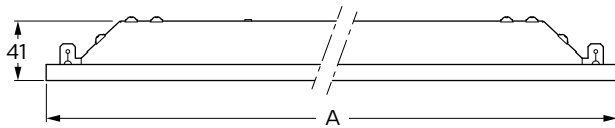

W30L120

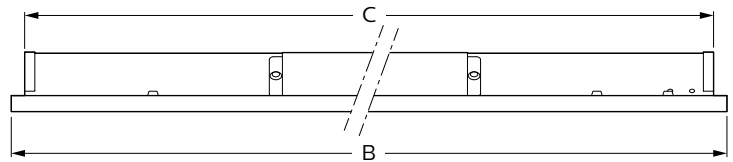
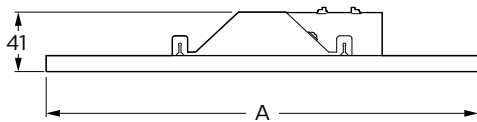

Curent de pomire

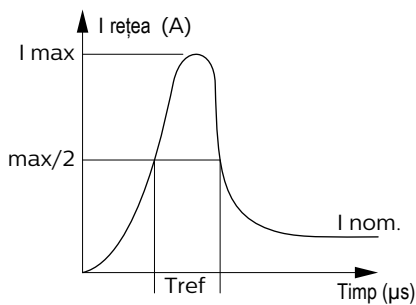

	LED34S
	Caracteristici electrice
Inom(mA)	240
I _{max} (A)	5,3
Tref(μs)	70
MCB	Corpuri de iluminat Max.
B-10A	15
B-16A	24
C-10A	24
C-16A	40



- Corpul de iluminat va fi montat de un electrician calificat, și cablat în conformitate cu cele mai recente regulamente electrice IEE sau cu cerințele naționale.

- Placa cu LED-uri și balastul LED nu pot fi reparate și înlocuite



ATENȚIE
RESPECTAȚI MĂSURILE DE
PRECAUȚIE PENTRU MANIPULARE
DISPOZITIVE
VULNERABILE LA
DESCĂRCĂRI
ELECTROSTATICE

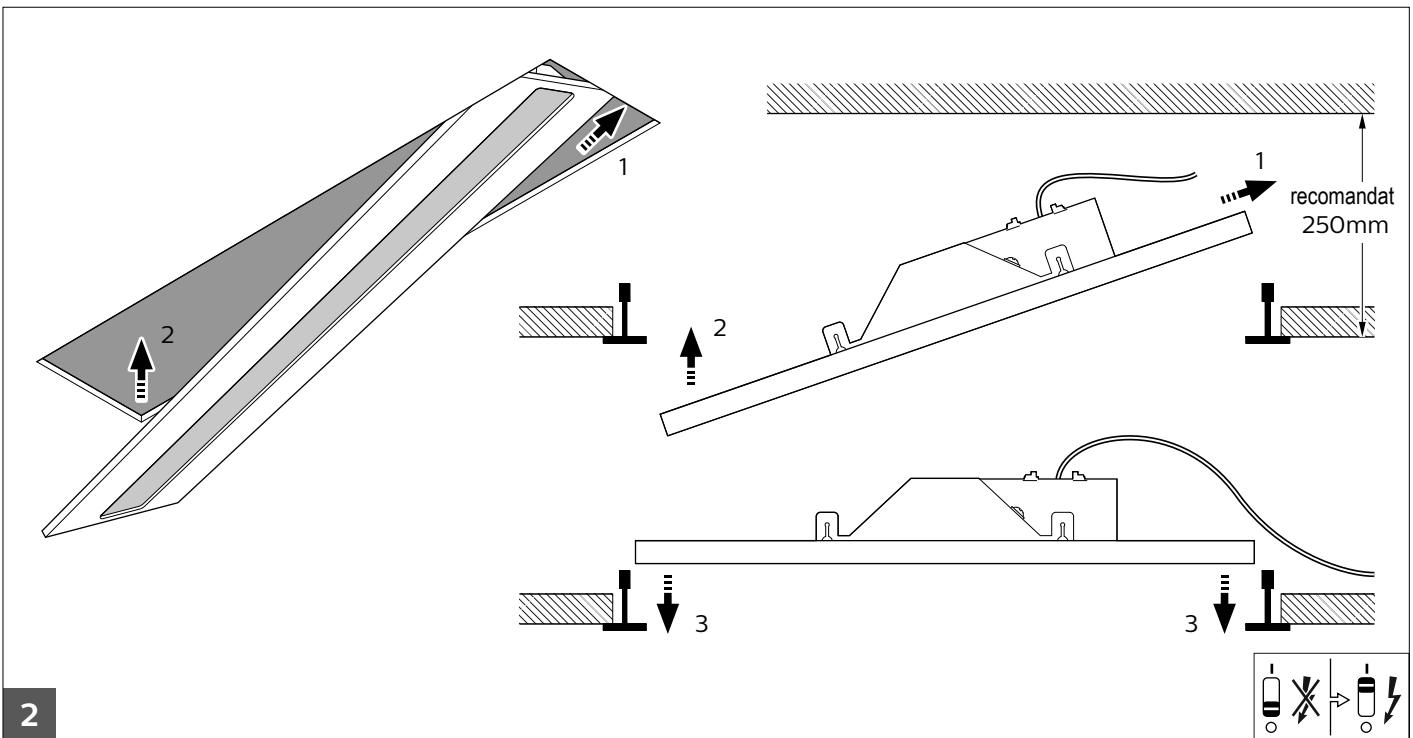
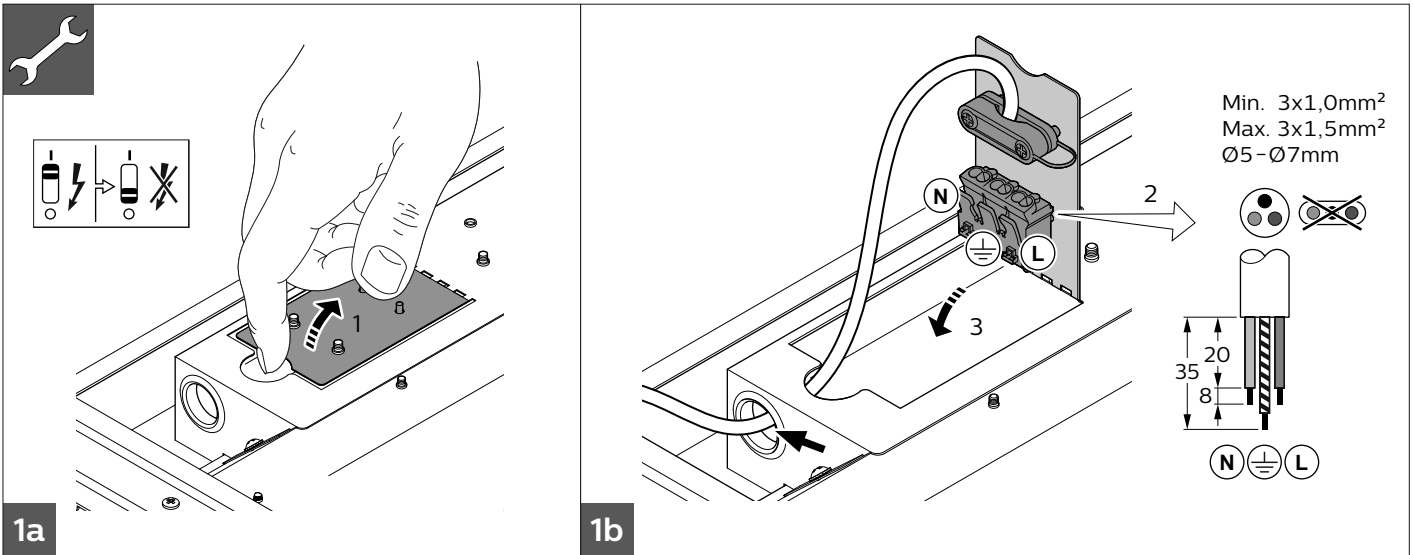

adăugați un cablu de siguranță, dacă este necesar

