

SANICA
RADYATÖR

PANEL RADIATOR TECHNICAL MANUAL

- Assembly
- Operation
- Maintenance

CONTENTS

GENERAL INFORMATION

Introduction	3
Main Components	3

TECHNICAL INFORMATION

Technical Properties	4
Dimensions	4
Models	6

TYPES

Standard Types	7
Compact Screw Feeder Types	9
Assembly Accessories	12

WARNINGS

For Efficient Operation	13
Issues to be Considered during Operation	13

CRITERIA FOR RADIATOR SELECTION

Pressure Loss	14
Capacities in Different Environment Temperatures	14
Radiator Capacity Factor (F) Table	15

PACKAGE AND TRANSPORTATION

Palette Package	16
Transportation and Loading	16

PLACEMENT PRINCIPLES

Recommendations for Suitable Placement	17
Issues to be considered in regards to Comfort	18
Issues to be considered in regards to Radiator Efficiency	19
Recommendations for Radiator-Installation Line Connection	20

ASSEMBLY

General Information	23
Implementation	23
Hanger Dimensions	24
Assembly Dimensions	25

HEAT – POWER TABLES

WARRANTY AND CERTIFICATES

Manufacturer

SANICA ISI SANAYİ A.Ş.

Kavaklı köyü, Gürpınar Yolu Üzeri, 34900

Büyükkçekmece / İSTANBUL

Phone : 0 212 876 60 60 (Pbx), Fax : 0 212 876 60 70

Email : radylator@sanica.com.tr, Web : www.sanica.com.tr

INTRODUCTION

This catalogue includes technical information, the data required for best radiator type selection depending on various placement and operation conditions, placement and assembly recommendations for correct and efficient utilization.

Sanica Panel Radiators are manufactured in modern production lines equipped with computers and high technology in Manisa – AKHİSAR facilities of Sanica with ISO 9001 certificates.

Compliant to TS EN 442-1 standards, Sanica Panel Radiators are being used in the local market commonly and also exported abroad.



MAIN COMPONENTS

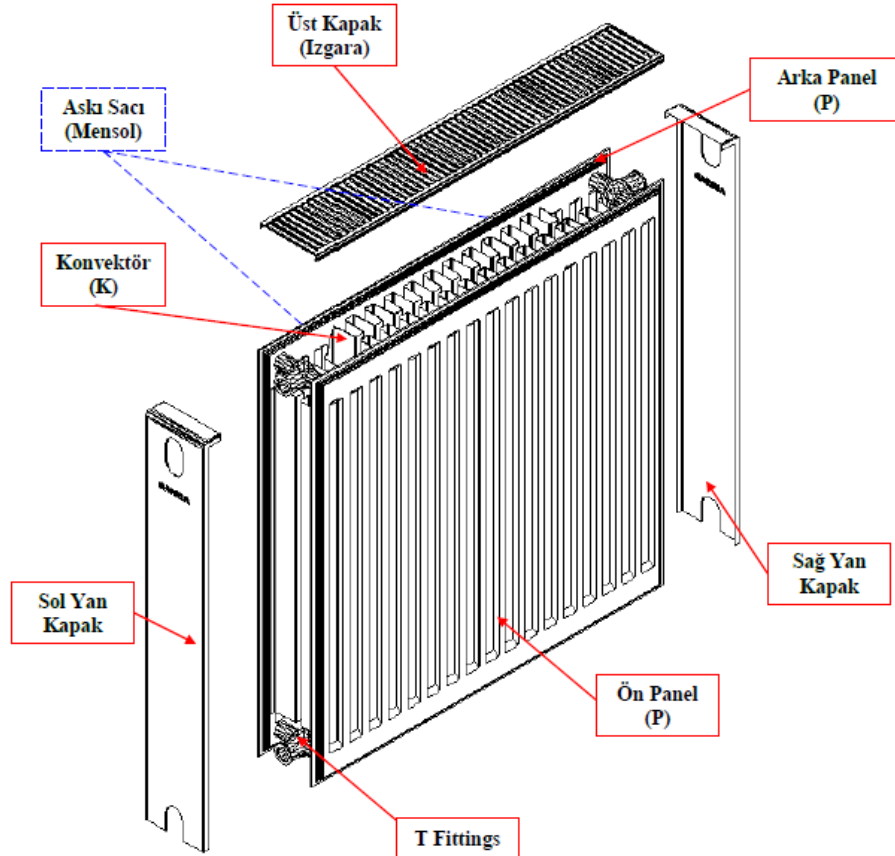

Askı Sacı (Mensol)	Hanger Plate (Mensol)
Üst Kapak (Izgara)	Upper Cover (Grille)
Arka Panel (P)	Back Panel (P)
Sağ Yan Kapak	Right Side Cover
Ön Panel (P)	Front Panel (P)
T Fittings	T Fittings
Sol Yan Kapak	Left Side Cover
Konvektör (K)	Convector (K)

TECHNICAL INFORMATION

Radiator Panel (P) Sheet	1,11 mm sheet
Convactor (K) Sheet	0,31 mm sheet
Cover Sheet	0,50 mm sheet
Panel (P) and Convactor (K) Sheet Standard	DIN 10130 – DIN 10131
Maximum Operation Pressure	10 Bar
Test Pressure	13 Bar
Maximum Operation Temperature	110 °C
Radiator Connection Coupling	4 x G ½’’
Color	RAL 9016
Paint Specifications	Primer: Epoxy Ester (Melamine Resin Based Water Based Dip Primer) Powder Paint: Epoxy – Polyester (Semi Matt)

Dimensions

4 Model	: Standard, With Cover, Compact, Compact with Cover
6 Types	: 10 – 11 – 20 – 21 – 22 – 33
6 Height (mm)	: 300 – 400 – 500 – 600 – 750 – 900
Length (mm)	: from 400 mm to 3000 mm

Sanica Panel radiators are manufactured in 6 different height, 6 different type and length choices from 400 mm to 3000 mm with 800 mm intervals.

Length (mm)	400	500	600	700	800	900	1000	1100	1200	1300	1400
Length (mm)	1500	1600	1700	1800	1900	2000	2100 2200	2300 2400	2500 2600	2700 2800	2900 3000

Nominal Height (mm)	300	400	500	600	750	900
Physical Height (mm)	300	400	500	600	750	900
Manifold Distance (mm)	245	345	445	545	695	845

Surface Cleaning

The surfaces of the radiator have their oil extracted with used nano-technological and ecological chemical agents and the resistance of the sheet is increased with coating properties in the chemical agents used.

Paint

The panel radiators are painted with two layers of high quality paint.

1st Layer: The primer (wet) paint is implemented with dipping method and all surfaces of the radiator and the convector is painted.

2nd Layer: Powder paint (**epoxy polyester RAL 9016**). It is coated with standard paint thickness and therefore gains high protection properties.

Package

It can be carried without any damage thanks to its special protection package.

All assembly components such as console (wall hanger component), air relief cork, dummy plug, air relief key, lag screw, dowel, console crimp and hanger component are included in the package.



Standard

All radiators are manufactured according to TS EN 442-1 standard.

“CE” Directive Produit de Construction 89/106/CEE

No. 1623 BR 015

CETIAT

RAL

Warranty

Sanica Panel Radiators are under warranty for 12 years.

MODELS

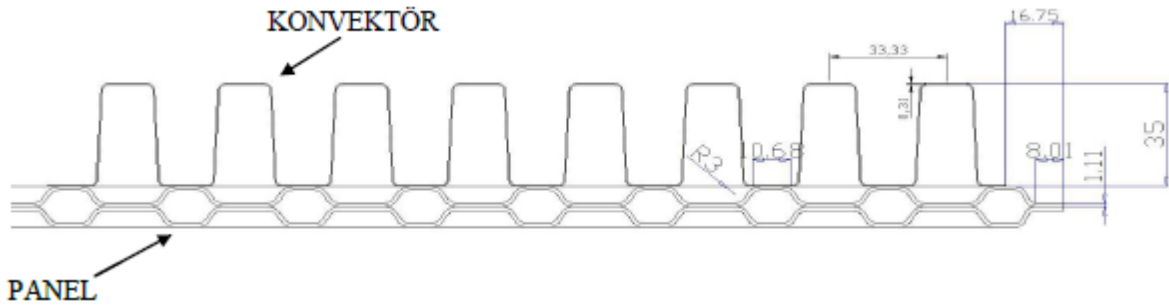

KONVEKTÖR	CONVECTOR
PANEL	PANEL

- Sanica Panel Radiators consists of Panel (P) and Convectors (K).
- The panels are manufactured from two sheets formed with grooves in automatic press machines and connected with machine welding in automatic benches. Hot water circulates in the channel created between the grooves. The hot water heats the surfaces of the panel.
- The panels are welded with a sheet formed with grooves. This sheet is called Convector. The air rising above between the convectors is heated with the contact of convector heating from the hot panel surface and mixes into the environment.

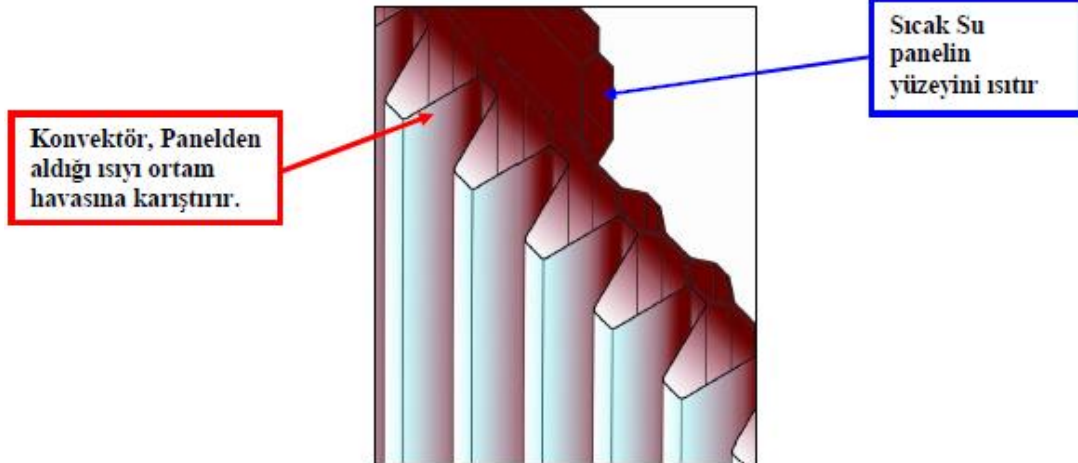



Konvektör, Panelden aldığı...	The convector mixes the heat obtained from the panel into the air.
Sıcak Su panelin...	The hot water heats the surface of the panel.

- The panel radiator models are separated by their panel and convector numbers.
- The panels (P) are indicated with convectors (K). For example, (PKKP) model consists of “Panel-Convactor-Convactor-Panel” starting from the back panel.
- The models may be indicated with numbers. The first digit of a two digit model indicates the panel number and the second digit indicates the convector number. For example, “PKKP” model is indicated as “Type 22” as it consists of 2 panels and 2 convectors. For another example, “PKP” model has 2 panels and 1 convector, therefore indicated as “Type 21”.

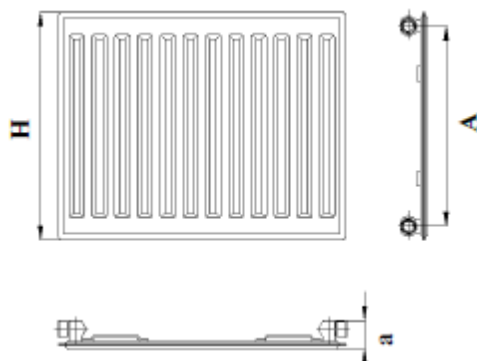
<p>TYPES</p> <p>Sanica Panel Radiators are divided into four groups as “Standard”, “Compact Valve”, Middle Compact Valve” and “Flat (plane)” types depending on their installation connection. The standard types are indicated as (S), Compact Valve types are indicated as (C), Middle Compact Valve Types are indicated as (OC) and Flat Plane Types are indicated as (F).</p> <p>The Standard and Compact Valve Types has “slim types” for 20 PP and 21 PKP models. The slim types are indicated with (I).</p> <p>Standard Types</p> <p>The standard types are connected with four welded T or L parts (for 10P/S and 11PK/S models) located on the sides of radiator heating installation. T part allows the radiator to be connectd to the installation with various methods. Thus, the radiator may be operated in different installations and special placement situations.</p>	<p>Standard Type</p> 
---	--

TYPE: 10 S				
DIMENSIONS		WEIGHT With Cover (Kg/m)	WATER VOLUME (Lt/m)	
Radiator Height (H)	Manifold Distance (A)			
300	245	7,6	1,7	
400	345	9,6	2,1	
500	445	12,1	2,6	
600	545	14,5	3,1	
750	695	17,1	3,6	
900	845	20,6	4,1	
				Standard Width: A = 50 mm

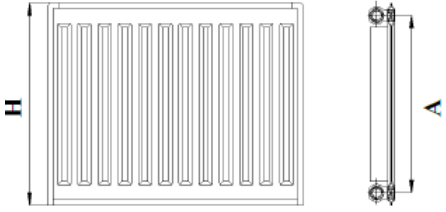
TYPE: 11 S			
DIMENSIONS		WEIGHT With Cover (Kg/m)	WATER VOLUME (Lt/m)
Radiator Height (H)	Manifold Distance (A)		
300	245	8,6	1,7
400	345	11,5	2,1
500	445	14,6	2,6
600	545	15,1	3,1
750	695	21,6	3,6
900	845	25,5	4,1



Standard Width: a = 60 mm

TYPE: 20 S			
DIMENSIONS		WEIGHT With Cover (Kg/m)	WATER VOLUME (Lt/m)
Radiator Height (H)	Manifold Distance (A)		
300	245	15,2	3,4
400	345	19,2	4,2
500	445	24,2	5,2
600	545	29	6,2
750	695	34,2	7,2
900	845	41,2	8,2

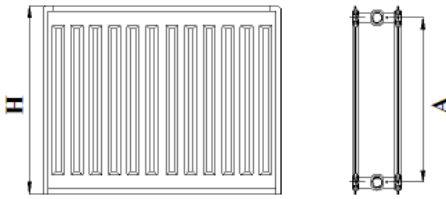
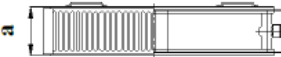
Standard Width: a = 70 mm

TYPE: 21 S			
DIMENSIONS		WEIGHT With Cover (Kg/m)	WATER VOLUME (Lt/m)
Radiator Height (H)	Manifold Distance (A)		
300	245	15,8	3,4
400	345	20,8	4,2
500	445	24,7	5,2
600	545	30,7	6,2
750	695	38,4	7,2
900	845	46,1	8,2

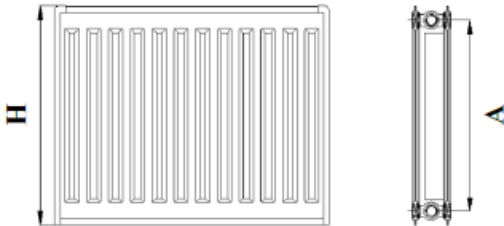
Standard Width: a = 103 - 70 mm

TYPE: 22 S			
DIMENSIONS		WEIGHT With Cover (Kg/m)	WATER VOLUME (Lt/m)
Radiator Height (H)	Manifold Distance (A)		
300	245	17,2	3,4
400	345	22,7	4,2
500	445	26,05	5,2
600	545	32,10	6,2
750	695	42,6	7,2
900	845	51	8,2

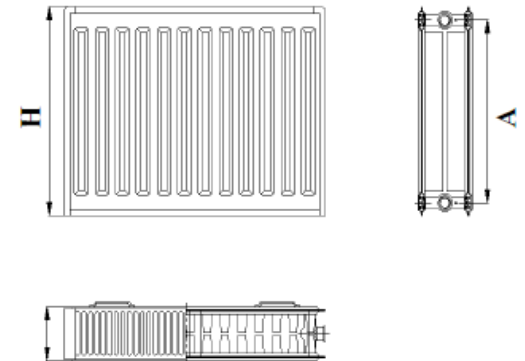

Standard Width: a = 103 mm

TYPE: 33 S			
DIMENSIONS		WEIGHT With Cover (Kg/m)	WATER VOLUME (Lt/m)
Radiator Height (H)	Manifold Distance (A)		
300	245	23,37	6,2
400	345	31,26	7,4
500	445	36,69	8,85
600	545	45,11	10,4
750	695	51,40	12,2
900	845	68,06	14,9

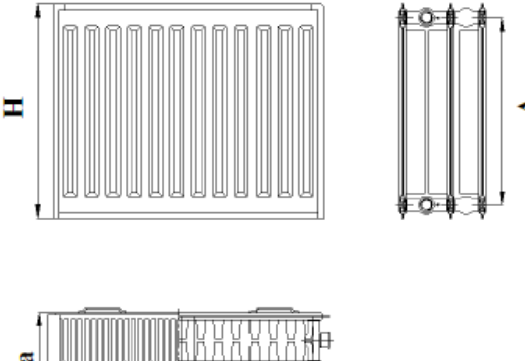

Standard Width: a = 162 mm

Compact Valve Types

The radiator may be connected to the installation from below for compact valve types. For this, special connection components are placed at right, left and middle of the radiator instead of the T and L fitting components of standard types.

The entry and exit connection outlets to and from the radiator are located at the below. The upper section allows the installation water entered to the radiator from below to be distributed into the water channels and if desired allows the installation of thermostatic valve.

While ordering compact valve radiator, a radiator suitable to the installation must be selected. For example, if the pipe entry and exit is located on the right, the compact valve on right must be selected.

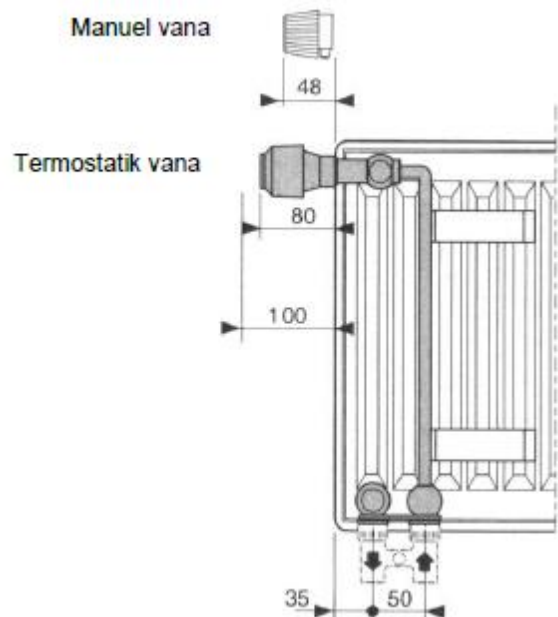

Manuel vana	Manual Valve
Termostatik vana	Thermostatic Valve

The thermostatic valves are recommended for compact valve panel radiators. Each radiator may be commanded separately in thermostatic ways. The temperatures of the radiators are checked in an easy and economical way. If the valve is not be utilized, the upper connection outlet must be closed off with dummy plug.

MIDDLE COMPACT MODEL

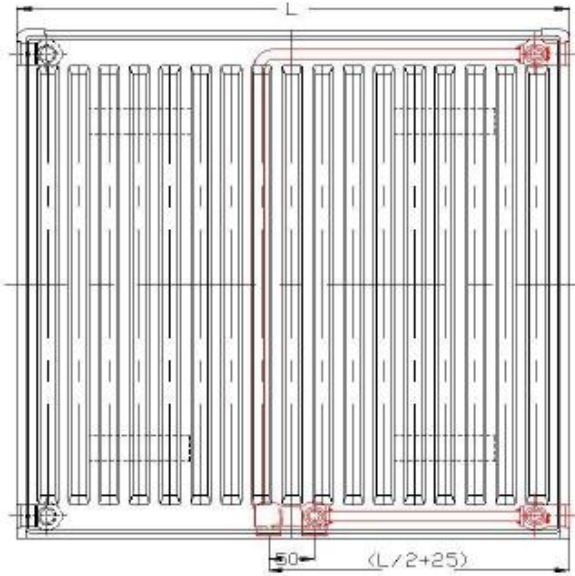

The new feeding system of the compact panel radiators are made for double pipe feeding. The other properties:

- Kv system which is adjustable for the necessities and sink valve is located on the top.
- The sink valve may be operated with thermostatic way or manual way.
- The male feeding connection orifices which have diameter 20/27 are located on the bottom.
- For double pipe installations, the orifices in compact has copper and plastic connection components.
- For single pipe installations, the bypass components under the radiator which may be directly adapted are kept as additional materials. These bypass components allows the insulation of the radiator and adjustment of sharing coefficients.

Double Pipe Version

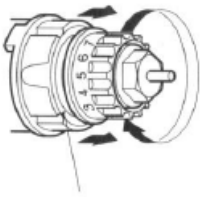
 <p>Ayarlanabilir vana</p>	<p>The adjustable Kv sink allows a wide interval for load losses.</p>	Adjustment	Thermostatic Valve	Manual Valve
			Kv (xp = 2K)	Kvs
		1	0,09	0,09
		2	0,17	0,17
		3	0,23	0,24
		4	0,30	0,32
		5	0,40	0,43
		6	0,53	0,62
		7	0,64	0,79
N	0,72	0,87		

Ayarlanabilir vana	Adjustable Valve
--------------------	------------------

Single Pipe Model Bypass



The adjustment screw is manufactured as 35% of sharing coefficient for thermostatic valve and 40% of sharing coefficient for manual valve.

Bypass Cycle Number	Thermostatic Valve Xp = 2K		Manual Valve	
	Kv		Kvs	
1 ¾	1,45	50%	1,60	50%
2 ¼	1,63	45%	1,75	46%
2 ¾	1,71	40%	1,85	43%
3	1,85	35%	2,00	40%

Note: In this case, the adjustment ring on the valve is put to N status.

LOAD LOSSES OF COMPACT VALVE RADIATOR

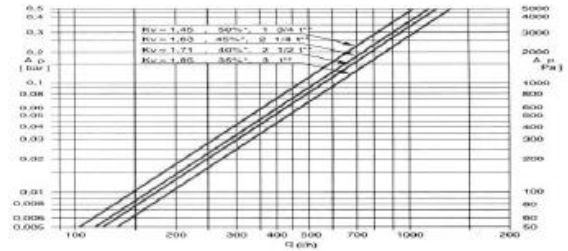
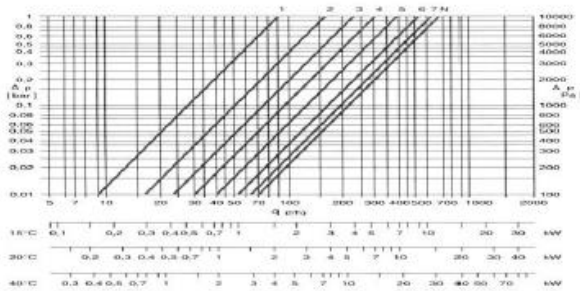

Formula: $q = Kv \sqrt{\Delta p \cdot 10^5}$;

$Kv = \frac{q}{10 \sqrt{\Delta p}}$;

$\Delta p = \left(\frac{q}{10 \cdot Kv} \right)^2$

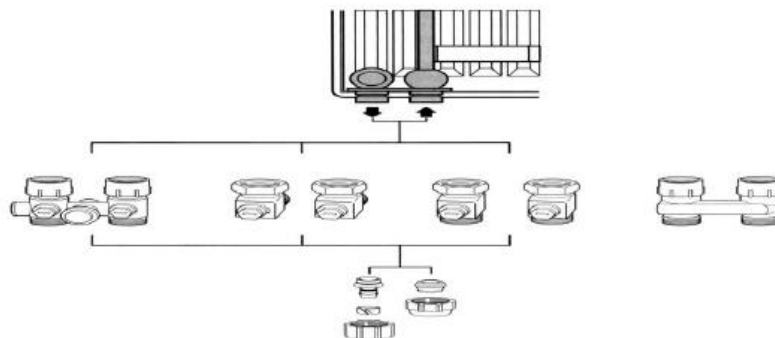

ADDITIONAL MATERIALS

Assembly Accessories

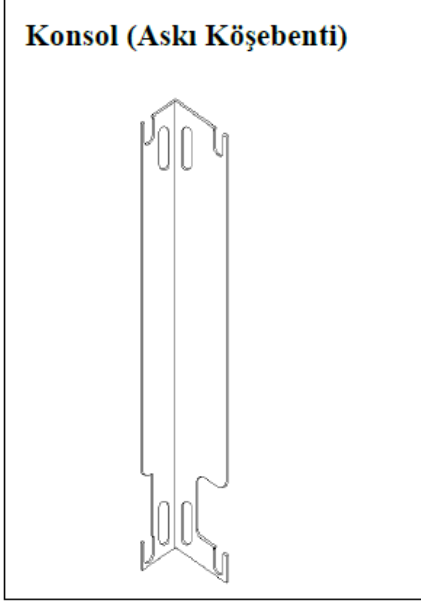

Height (mm)	Console Length (mm)
300	108
400	208
500	308
600	408
750	558
900	708

Konsol (Askı Köşebentli)	Console (Hanger Bracket)
--------------------------	--------------------------

Accessory Bag

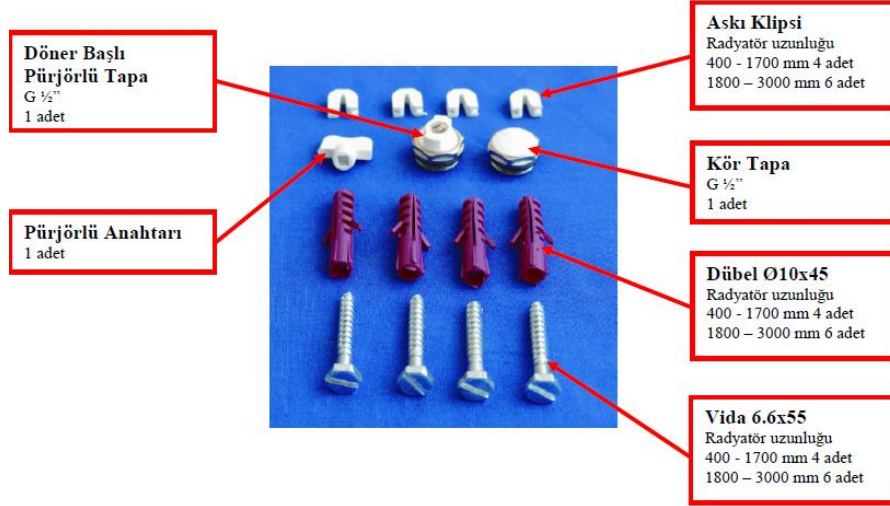

Döner Başlı Pürjörülü Tapa	Rotary Plug with Air Relief Valve G ½" 1 piece
Pürjörülü Anahtarı	Switch with Air Relief Valve 1 piece
Askı Klipsi	Hanger Crimp Radiator Length 400 - 1700 mm 4 pieces 1800 - 3000 mm 6 pieces
Kör Tapa	Dummy Plug G ½" 1 piece
Dübel 10x45 çap	Dowel, diameter: 10x45 Radiator length 400 - 1700 mm 4 pieces 1800 - 3000 mm 6 pieces
Vida 6.6x55	Screw 6.6x55 Radiator length 400 - 1700 mm 4 pieces 1800 - 3000 mm 6 pieces

FOR EFFICIENT OPERATION

The panel radiators is a part of the heating system consisting of heating device (boiler, central heating boiler, etc.), circulation pump, installation pipes, fittings, valves and other accessories. Efficient, economic and safe operation of a radiator depends on the efficient operation of other components of the heating system. Therefore, the steps provided below shall be considered before the selection and placement of the radiator.

- Correct Heating Device

The capacity of the heating device shall satisfy the heating necessity of the environment to be heating.

- Correct Installation

The force of the circulation pump and the selected pipe diameters shall allow the circulation of the installation water without any restriction in the flow rate designed. The generation of air in the installation must be prevented and when necessary the air relief devices must be installed to relieve air from the installation.

- Correct Implementation

The implementation of the heating system shall be in accordance with the project and the standards. Before the commissioning of the system, the dirt in the installation must be cleaned. In case that the water hardness is higher than the desired value, the system and radiator must be equipped with a filter and water softening device for preventing lime and residues from collecting.

- Correct Insulation

The environment to be heated must be insulated in order to benefit from the energy produced efficiently. Therefore, the heat transmission from the environment is minimized and economic heating is obtained.

Issues to be considered for Operation

- 1- The efficiency desired from the radiator depends on the selection of the radiator suitable for the need and the conditions of placement. This booklet includes criteria, graphics and tables which may be used for selection of the radiator. The necessary warnings are made for placement. Before the selection of the radiator, these sections must be examined carefully.
- 2- The air stuck in the radiator must be relieved with air relief valve for efficient operation and homogenous heating of radiators.
- 3- The maximum operation pressure of the radiators is 10 bar. The radiator should not be operated over this pressure.
- 4- The radiator entry and exits must have valves. In case that there is a problem, the radiator must be taken out of the circulation by closing the valve without requiring the system to be stopped.
- 5- The water in the radiator must not be emptied even when the system is not operated for long periods. In case that emptying the water in the system is required during the reparations or maintenance of the installation, the valves of the radiator must be closed and water must be kept in the radiator. Otherwise, the corrosive materials generated in the radiator will affect the radiator negatively and may damage the installation.
- 6- The radiators must not be operated in open areas with a danger of freezing. The temperature where the radiator is placed must not go below 0 °C. If the water in the installation freezes, both radiator and the installation may be damaged. In case that the installation and the radiator must be placed in an environment below 0 °C, antifreeze agents must be added to the water of the installation.
- 7- The maximum operation temperature of the radiator is 110 °C. The radiator must not be operated for temperatures higher than this value.
- 8- The chemical cleaning agents must not be used for cleaning the surface of the radiator. The radiators may be wiped with a moist dustcloth.

CRITERIA FOR RADIATOR SELECTION

The efficiency desired from the radiator depends on the selection of the radiator suitable for the need. During the selection process, the pressure loss in the radiator, capacity changes depending on various water entry-exit and room temperatures must be calculated.

In addition, the method of connection to installation and placement conditions also affect the efficiency of the radiator. Therefore, these conditions must be considered for selection of panel radiators.

Capacities in Various Environment Temperatures

The standard "Heat-Power Values" in the panel radiators are made for 90/70 °C water entry-exit temperature. This booklet also includes additional tables for various environment and water entry-exit temperatures apart from these standard values. If the data is in accordance with these values, the Heat-Power values may be obtained from these tables. The environment temperature and water entry-exit temperatures must be used to calculate the Heat-Power Values with utilization of "F Factor" (f) in Table 1 in various values.

Example 1 – Calculation of Heat-Power Value by using "F Factor" (f):

Radiator Type = 22, Height = 600 mm

Length = 1500 mm (22x600x1500)

Temperature of Water entering into the Radiator : 80 °C

Temperature of Water exiting from the Radiator : 65 °C

Environment Temperature : 22 °C

From the Table 1, environment temperature of 22 °C, temperature of water entering into the Radiator of 80 °C and temperature of water exiting from the radiator of 65 °C is found as **f=1.25**. The Heat-Power Value (Qn) of the radiator with dimensions 22x600x1000 is obtained as **Qn;=2139** from Table 3 in Page 28 with 90/70 °C enter-exit temperatures and environment temperature of 20 °C.

The Heat-Power Value for environment temperature of 22 °C, temperature of water entering into the Radiator of 80 °C and temperature of water exiting from the radiator of 65 °C:

Q=Qn/f Formula No. 1

Q=2139/1.25 = 1711.2 Watt (1 meter)

In this case where it is 1711,2 watt/meter, the watt value of the radiator with dimensions 600x1500 we are operating is obtained as $1711,2 \times 1,5 = 2566,8$.

Example 2 – Selection of Radiator according to the Environment Temperature and Temperatures of Water entering to/exiting from the Radiator by the Heating Needs calculated:

Calculated heat need : 971 W

Temperature of Water entering into the Radiator : 80 °C

Temperature of Water exiting from the Radiator : 65 °C

Environment Temperature : 22 °C

From Table 1, **f=1.25** is found. From Formula No. 1:

Qn=Qxf=971x1.25=1213.75 Watt.

The radiator corresponding to this value is selected from the Table 3 in Page 28.

PACKAGE, TRANSPORTATION AND STORAGE

Sanica Panel Radiators are packaged after they undergo all quality control processes at the end of the production line. The panel radiator is protected against external effects, frictions and impacts during the transportation and assembly processes with the rigid packaging conducted with great care. The sides of the radiator is supported with cartons from end to end and the hanger sheets are protected against impacts with plastic covers. After all surfaces of the radiator are wrapped in bubble wrap, a second protective plastic cover is wrapped with shrink method.

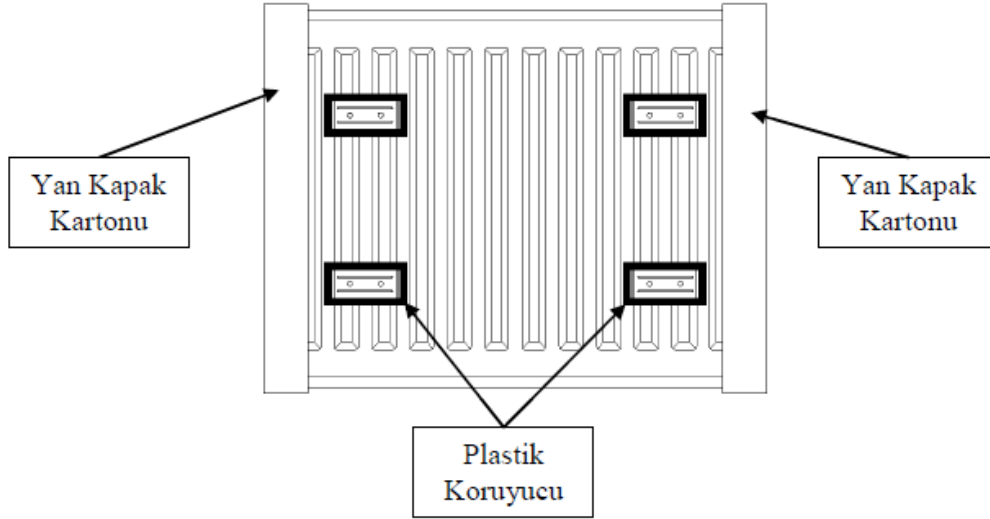

Yan Kapak Kartonu	Side Cover Carton
Plastik Koruyucu	Plastic Protector

Palette Package

Sanica Panel Radiators are also packaged on pallets to be transported easily and safely after being packaged separately.

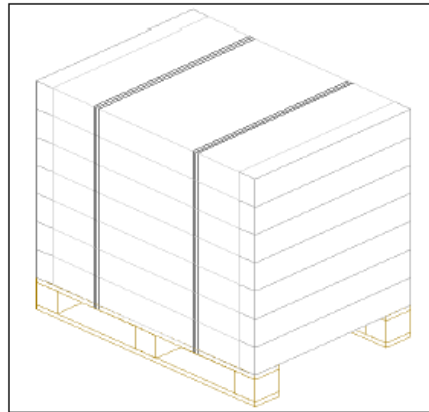

Boyuna üst üste sıralama

Boyuna üst üste sıralama	Lengthwise successive gradation
--------------------------	---------------------------------

Transportation and Loading

Sanica Panel Radiator pallets must be handled and transported with care and not dropped on the ground. The handling from a place to another must be conducted with a pallet carrier instead of pulling or pushing. The radiator pallet must be completely lifted off the ground and must not be subjected to friction. The necessary distances were allowed for ensuring the carrier to get under the pallet.

A balanced and safe lifting method is recommended for transportation of the pallet of radiators with any carrier.

PLACEMENT PRINCIPLES

The transmission of the heat obtained with hot water circulation in Sanica Panel Radiator is realized with heat transmission and radiation method.

Heating with heat transmission is realized with environment air to enter into the radiator from the bottom. The air heats while passing through the convectors and moves up. Then the heat air mixes into the environment air which is colder after passing through the grilles at the top of the radiator and releases the heat into the environment.

Heating with radiation is realized with radiation of the thermal energy obtained in the front and back panels of the radiator radiated to the environment.

Recommendations for Suitable Placement

The thermal transmission in panel radiators is mostly realized with heat convection. Therefore, for placing the radiators on the walls:

- An opening allowing the environment air to enter and leave the radiator with ease between the radiator, ground and the wall for ensuring an efficient heat transmission.

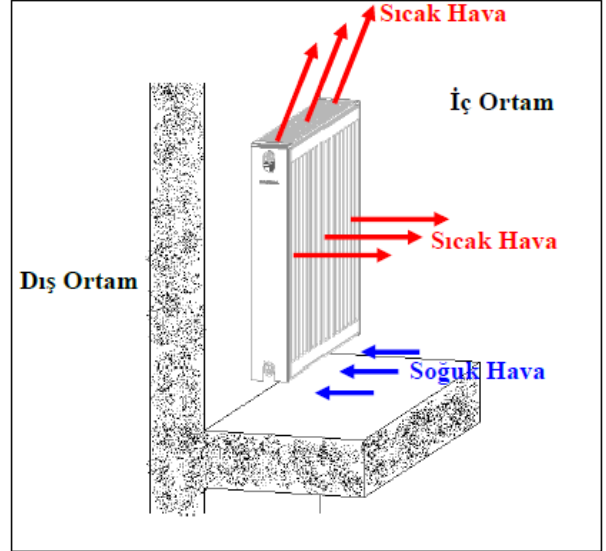
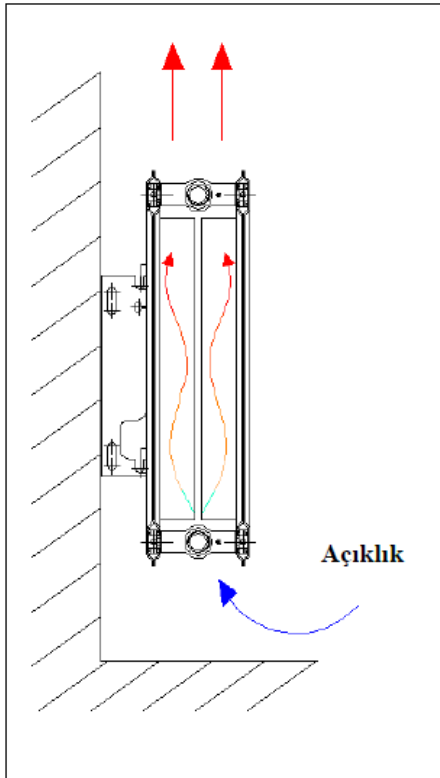

- Insulation is recommended to be implemented between the wall and the radiator in order to decrease the heat loss to external environment through the wall behind the radiator via radiation and increase the efficiency of the radiator.

The cold air mostly enters to internal environment through the openings in the case and frames of the windows. There is a natural air circulation based on the fact that the cold air moves to ground and the heated air moves to the ceiling in internal environments.

The heated air exiting the radiator under the window mixes with the cold fresh air entering from the window. The heated air increases the temperature of the cold air. The heated air ascends to the ceiling and goes back down to the ground when its temperature drops. The cold air on the ground moves to the radiator. Thus the hot air exiting the radiator spreads through the room homogenously and prevents the generation of areas with different temperatures in the same environment.

In case that the radiator is placed on any wall other than under a window, the cold air entering from the window descends to the ground and moves to the radiator. The hot air exiting the radiator ascends to the ceiling and moves to the window. The mixture of hot and cold air in the internal environment therefore is not homogenous. Therefore, it is not recommended to place the radiator on any wall other than under the window.

Sıcak Hava	Hot Air
Soğuk Hava	Cold Air
Dış Ortam	External Environment
İç Ortam	Internal Environment
Açıklık	Opening

Issues to be considered in regards to Comfort

There may be a recession on the wall under the window where the radiator will be placed. In this case, the radiator must be placed in this recession. In some environments the radiator is covered with furniture for decorative purposes. The most suitable placement desired is to have the top and environment of the radiator completely open. When the top or environment of the radiator is closed off, the air circulation and thus the efficiency of the radiator decreases.

The placement conditions of the radiator and efficiency decreased based on this is given in publications numbered TS 1499 and TS 2164/2. The explanations given below are based on these publications.

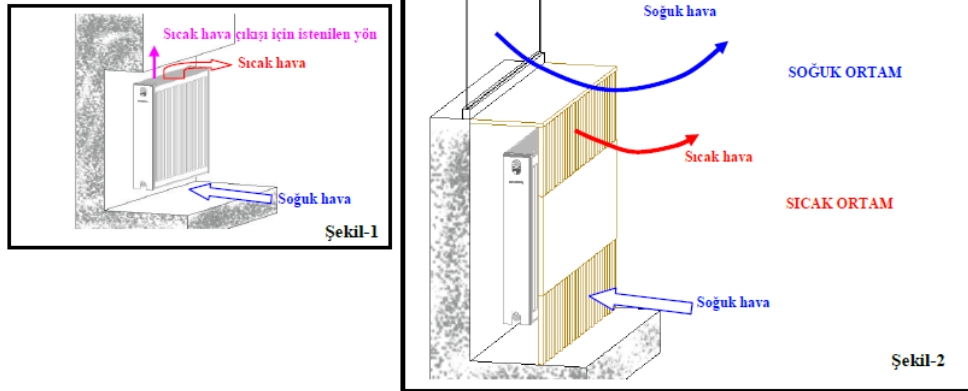

Sıcak Hava	Hot Air
Soğuk Hava	Cold Air
SICAK ORTAM	HOT ENVIRONMENT
SOĞUK ORTAM	COLD ENVIRONMENT
Sıcak hava çıkışı için istenilen yön	Desired Direction for Hot Air Exit
Şekil-1	Figure 1
Şekil-2	Figure 2

Having the top of the radiator closed affects the comfort conditions. Since the hot air mixes into the environment before reaching the window, the environment of the window and windows will be cold (**Figure 1**). The cold air circulation also affects the sitting areas (**Figure 2**).

In case that the top of the radiator is closed off, a cover with a grille must be used to keep the top of the radiator partially open (**Figure 3**).

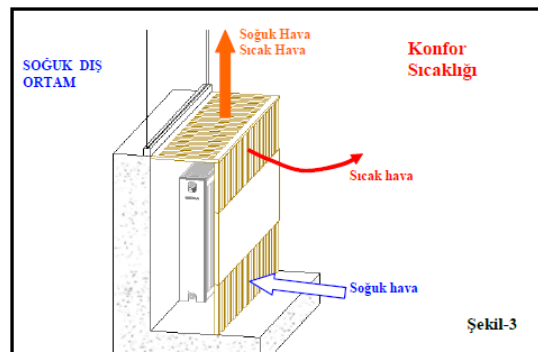

SOĞUK DIŞ ORTAM	COLD EXTERNAL ENVIRONMENT
Konfor Sıcaklığı	Comfort Temperature
Şekil-3	Figure 3

Issues to be considered in regards to Radiator Efficiency

As a result of covering the radiator and the top of the radiator, the air circulation between convectors are affected and the efficiency of the radiator is decreased. In this case, the efficiency loss arising from this reason must be calculated during the radiator selection. The ideal choice would be keeping the top of the radiator completely open and ensuring openings minimum 40 mm between the radiator and the wall and 100 mm below the radiator as stated in TS 2164/2. In this case, the efficiency of the radiator is accepted as 100%.

In case that the window platform closes the top of the radiator completely or partially, the efficiency is indicated as given below.

Opening (mm)	a	40	40	40	40
	b	-	80	80	80
Efficiency %		100	96	96	75

For various situations where the environment and the top of the radiator is covered with furniture, the efficiency change is given in the figures given below.

Opening (mm)	a	40	40	40	40
	b	100	50	80	80
Efficiency %		97	95	90	105

Recommendations for Installation Connection

The connection of the panel radiators to heating installation may be conducted in various ways depending on the placement conditions and radiator specifications.

It is suggested to put valves at the entry and exit points of the radiator connections. Therefore, the a single radiator may be separated from the installation by closing the valves while the heating system is operated and the installation water is not evacuated. The connection methods and information regarding the efficiency is provided below.

- Heated Water will enter the Radiator from Top and exit from Bottom

The water entry and exit may be on the same side or different sides. The entry and exit may be done on the right or left side of the radiator. This property allows assembly according to placement conditions. It is utilized widely.

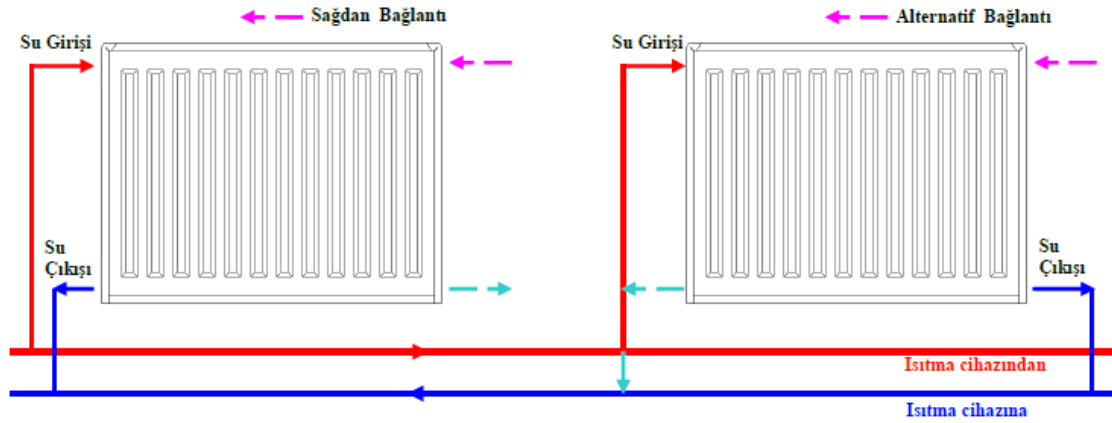

Sağdan Bağlantı	Connection from Right
Alternatif Bağlantı	Alternate Connection
Su Girişi	Water Entry
Su Çıkışı	Water Exit
Isıtma Cihazından	From Heating Device
Isıtma Cihazına	To Heating Device

- Connection on same side or different sides affects the efficiency with the change of water flow in the radiator.
- In the tests conducted, it was determined that the efficiency was not highly affected until height of 3000 mm for various radiator heights on all types. Therefore, Sanica Panel Radiators may be connected on both sides up to 3000 mm which is the maximum standard height for Sanica Panel Radiators.

- Heated Water will enter and exit from different sides and bottom of the Radiator

It is preferred in cases where the heated water enters the radiator not from top. It is not suggested to be used unless it is obligatory. The water entering the radiator from the top spreads on the upper section on the water channels and then descends. The water collected at the bottom is directed to the exit. Thus, the surface of the radiator is homogeneously heated. For entries from bottom, some of the water is directly directed to the exit from the bottom sections. Some of the water ascends. The water descending mixes with the moving water at the lower section. Therefore, the efficiency of the radiator connected from the bottom decreases from 10% to 20% depending on the radiator type, ratio of height and length of the radiator. This efficiency loss must be considered for selection of the radiator.

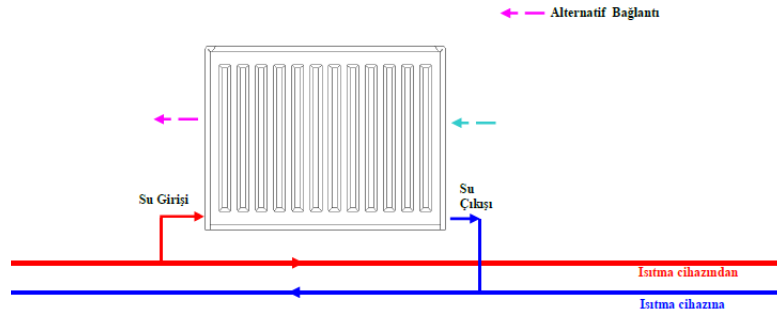

Su Girişi	Water Entry
Su Çıkışı	Water Exit
Isıtma Cihazından	From Heating Device
Isıtma Cihazına	To Heating Device
Alternatif Bağlantı	Alternate Connection

- Serial Radiator Connection

This connection method is utilized rarely when it is obligatory to operate more than one radiator; for example on a wall separately by columns because of construction specifications of the building. In this connection, the water leaving a radiator enters another radiator. Therefore, a temperature difference is obtained in each radiator. The water entry-exit may be conducted on the same side or different sides. For connections made on different sides, total heating power of the radiators connected serially is a little lower than the total of the thermal powers of the radiators separately. For connections made on the same side, total heating power of the radiators connected serially is 8-10% lower than the total of the thermal powers of the radiators separately. Thus, connections from different sides must be preferred on implementation and the efficiency loss must be calculated in case of connection on same side. Depending on the circulation pump in the installation, total thermal load on serially connected radiators must be exceed 7000-8000 Kcal/hour.

- Seri (yan yana) ve farklı taraftan bağlantı

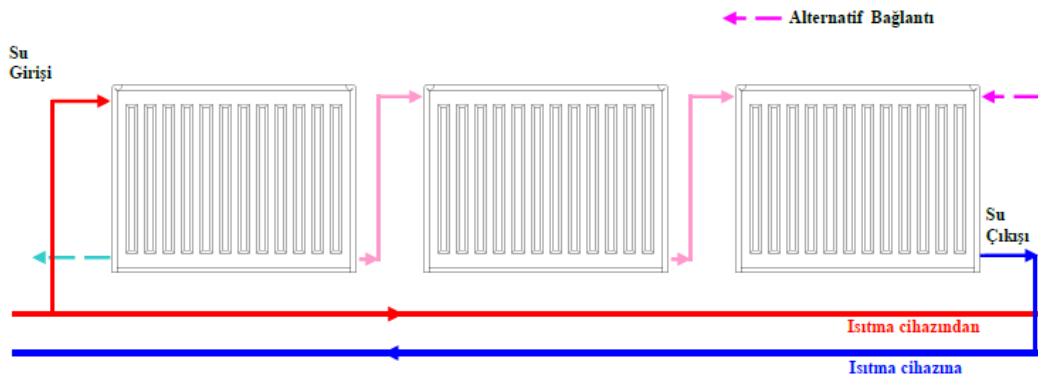

Su Girişi	Water Entry
Su Çıkışı	Water Exit
Isıtma Cihazından	From Heating Device
Isıtma Cihazına	To Heating Device
Alternatif Bağlantı	Alternate Connection
Seri (yan yana) ve farklı taraftan bağlantı	Serial connection on different sides

- Connection in Single Pipe Installations

Since the cold water exiting a radiator will decrease the temperature by mixing with hot water, the temperature of each radiator will be different for this connection. The pipe dimensions are of importance for an efficient heating. The radiator entry connection pipe must be selected bigger than the installation pipe to allow the water to enter the radiator and the radiator exit connection pipe must be selected smaller than the same to ensure complete circulation of the water in the radiator. In addition, the flow rate must be adjusted for each radiator with radiator valves to ensure circulation of the installation water and the flow rate of the first radiators must be decreased while the same of the last radiators must be increased.

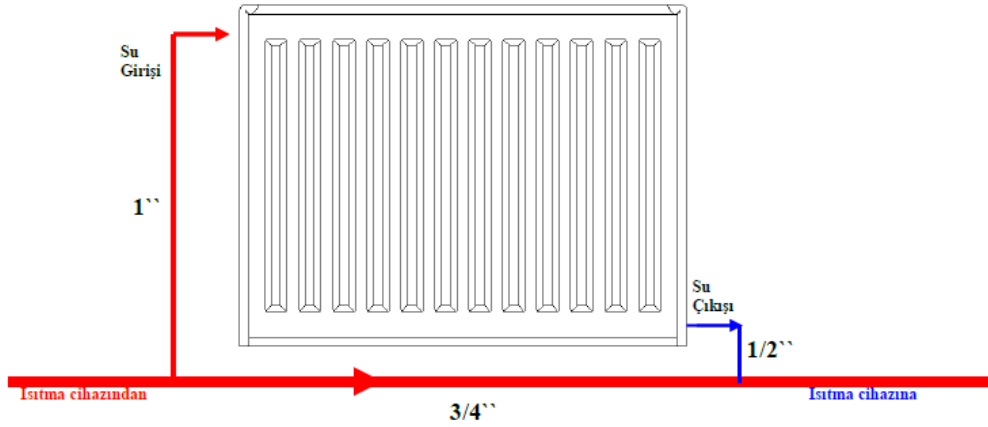

Su Girişi	Water Entry
Su Çıkışı	Water Exit
Isıtma Cihazından	From Heating Device
Isıtma Cihazına	To Heating Device

- Connection from the Bottom of the Radiators with Compact Valves

These type of connections are utilized for installations with covered pipes passing under the tiling and all installations constructed suitably. In addition, it may be preferred to decrease the piping aesthetically.

Sanical panel radiators are also manufactured with compact valves allowing connection to the installation from the bottom. The water entering from the bottom is directed upwards in the radiator with compact valves. The water is spread in the radiator as the connections from top and there is no loss of power.

It is suggested to utilize thermostatic valve heads with the panel radiators with compact valves. Therefore, the temperature may be checked for each radiator separately. While the radiator temperature is automatically checked, an economical heating is obtained.

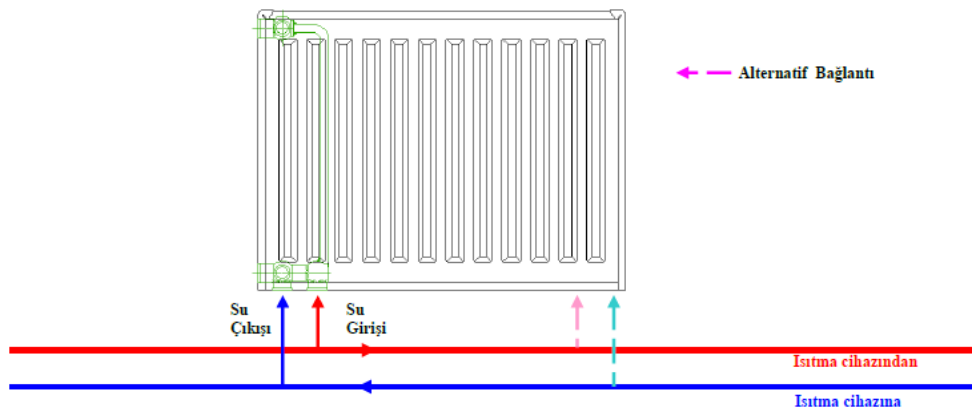

Su Girişi	Water Entry
Su Çıkışı	Water Exit
Isıtma Cihazından	From Heating Device
Isıtma Cihazına	To Heating Device
Alternatif Bağlantı	Alternate Connection

ASSEMBLY

The necessary assembly accessories for wall mounting of panel radiators are in a bag under the radiator. The hanger brackets are placed at the side of the radiator.

The radiators may be assembled before being taken out of their packages in order to prevent damages from occurring during installation processes. For this, only the accessories in the package are removed and the locations required for assembly are cut. The assembly accessories are taken out and the radiator is installed with its package.

After the installation processes, the packages of the radiators are completely removed and the radiators are rendered operable. This method is specifically suggested for the buildings being constructed.

In case that the radiators are to be kept in the construction site or a storage area, they shall be kept in their packages.

The bag of accessories consists of screws, dowels, hanger crimps, air relief valve and air relief switch and dummy cork. The screw, dowel and hanger crimps are utilized during the assembly. Their numbers are given in the "Assembly Accessories" section in the Page 12 depending on different radiator types.

The connection outlets of the radiators are closed off with plastic corks in order to prevent foreign materials to enter into the radiator. The plastic corks must be removed during installation connection and the connection outlets must not be kept open for long periods.

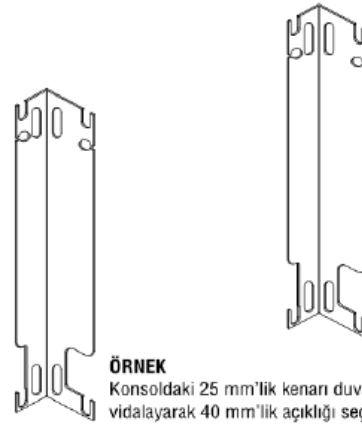
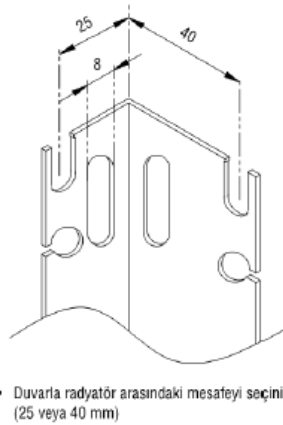

Duvarla radyatör arasındaki...	Select the distance between the wall and the radiator (25 or 40 mm)
ÖRNEK Konsoldaki...	EXAMPLE You choose an opening of 40 mm by screwing 25 mm side on the console to the wall

- Determine right and left consoles.

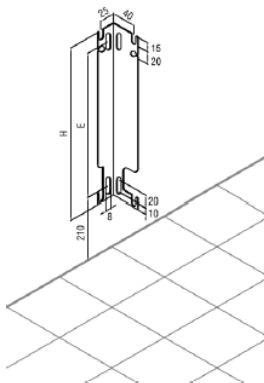

Radiator Height	Console Length H (mm)	Connection Channel Distance E (mm)
300	108	55
400	208	100
500	308	200
600	408	300
750	558	450
900	708	600

CONSOLE CRIMP ASSEMBLY

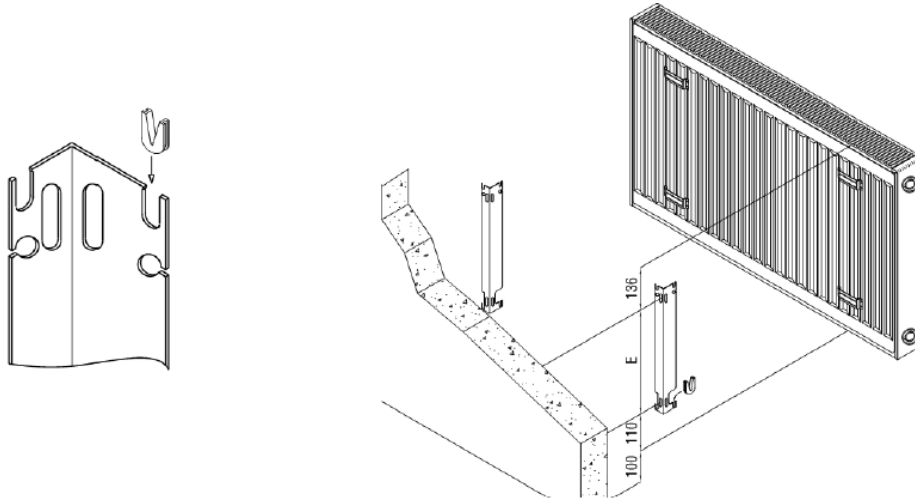

- Fit the radiator into crimps.
- Align the radiator to the console without using excessive force.
- Lock the console lock on the Mensol (Hanger Bridge).
- Plug a cotter pin into the hole located on the console lock for safety in order to prevent having it loosened.

Mensol (Hanger) Dimensions

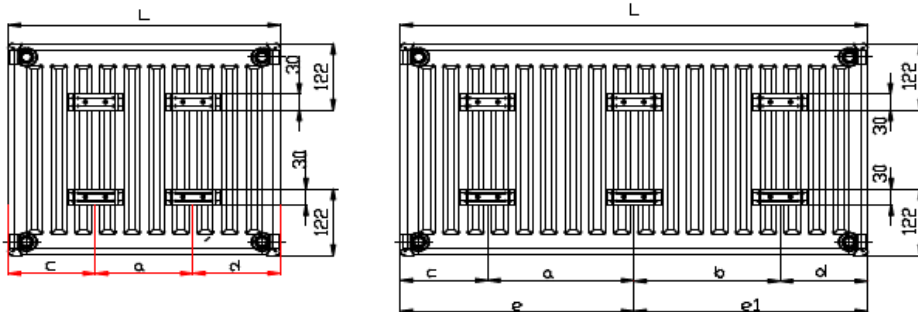

For 4 Mensols;

Between 10 – 42 steps (400-1600 mm length)

Standard Panel Radiators and Panel Radiators with Covers						
Length	10, 11, 21, 22, 33					
	a	b	c	d	e	e1
400-1600	L-270	-	135	135	-	-
1700, 1900... 2900	(L-600/2)	L-600/2	135	135	(L/2)	L/2

For 6 Mensols;

Between 43 – 90 steps (1700-3000 mm length)

Standard Panel Radiators and Panel Radiators with Covers				
Length	10, 11, 21, 22, 33			
	e	e1	c	d
1600, 1800, 2000, 2200, 2400, 2600, 2800, 3000	L/2	L/2	135	135

ASSEMBLY DIMENSIONS

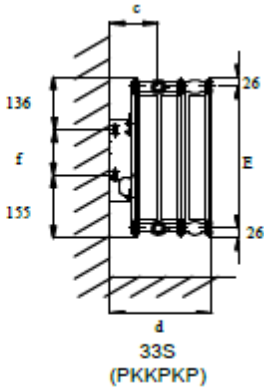
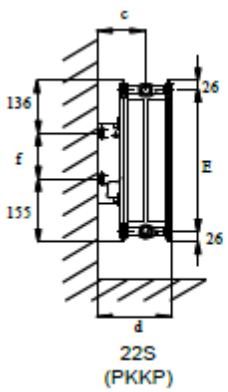
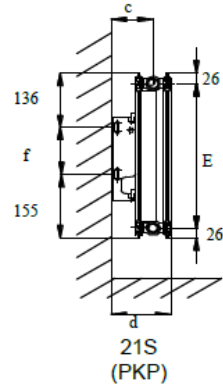
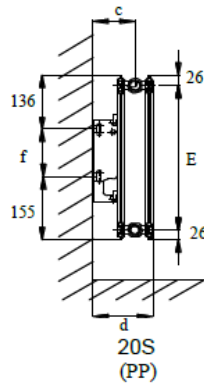
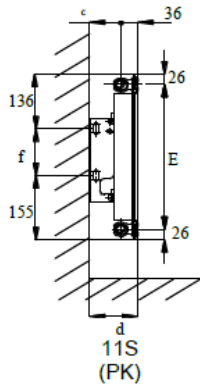
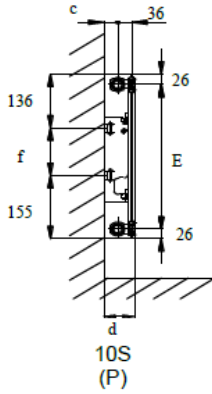

Physical Height	300	400	500	600	750	900
f	55	100	200	300	450	600
Bracket Distance E	245	345	445	545	695	845

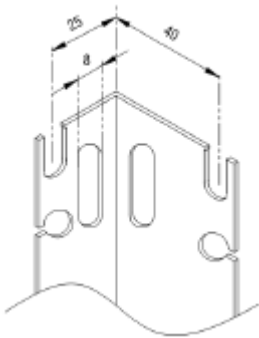

- Select the distance between the wall and the radiator (25 mm or 40 mm)

Type	Console Dimension	c	d
10	40	28	64
	25	13	49
11	40	56	92
	25	41	77
20-21	40	69	122
	25	54	107
22	40	102	155
	25	87	140
33	40	102	213
	25	87	198

COMPACT ASSEMBLY DIMENSIONS

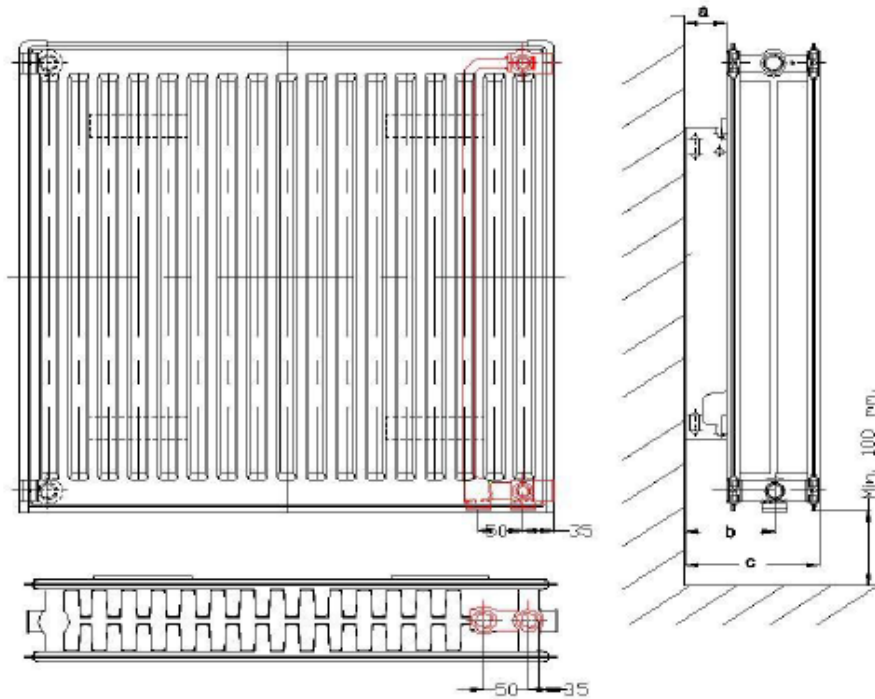

Type	Console Dimension a	c	d
10	40	28	64
	25	13	49
11	40	56	92
	25	41	77
20-21	40	69	122
	25	54	107
22	40	102	155
	25	87	140
33	40	102	213
	25	87	198

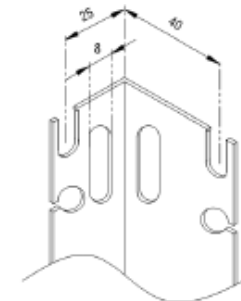

- Select the distance between the wall and the radiator (25 mm or 40 mm)

THERMAL CAPACITY AT 50 °C AT 70 °C (75 °C/65 °C) WATER TEMPERATURE

HEIGHT (mm)	300						400						500						600						750						900						
	p	PK	PP	PKP	PK KP	PKKP P	p	PK	PP	PKP	PKKP	PK KP	p	PK	PP	PKP	PK KP	PKKP P	p	PK	PP	PKP	PK KP	PKKP P	p	PK	PP	PKP	PK P	PKKP KP	p	PK	PP	PKP	PK KP	PK KP	
ROOM TEMPE																																					
10°C	Kcal / hm	347	560	619	814	1032	1447	448	721	791	1029	1317	1841	544	876	948	1236	1579	2216	608	1012	1103	1419	1839	2532	719	1174	1271	1648	2119	2905	858	1384	1492	2047	2616	3576
	Watt / m	404	652	720	946	1200	1683	521	838	919	1196	1532	2141	632	1019	1102	1438	1836	2577	707	1177	1283	1650	2139	2945	836	1365	1479	1917	2464	3379	998	1609	1735	2381	3043	4159
	Btu / hm	1378	2223	2457	3228	4095	5742	1777	2860	3137	4082	5226	7306	2158	3475	3761	4905	6266	8793	2414	4017	4377	5629	7297	1004	2852	4659	5045	6540	8409	1153	3406	5490	5919	8124	10381	1419
12°C	Kcal / hm	331	534	590	775	983	1378	426	686	753	980	1254	1753	518	834	903	1177	1504	2110	579	964	1050	1351	1751	2412	684	1118	1211	1570	2018	2767	817	1318	1421	1852	2367	3235
	Watt / m	385	620	686	901	1143	1603	496	798	876	1139	1459	2039	602	970	1050	1369	1749	2454	674	1121	1222	1571	2037	2805	796	1300	1408	1825	2347	3218	951	1532	1652	2154	2753	3763
	Btu / hm	1312	2117	2340	3075	3900	5468	1692	2724	2988	3888	4977	6958	2055	3310	3582	4672	5968	8374	2299	3826	4168	5361	6950	9571	2716	4437	4805	6229	8008	1098	3244	5229	5638	7350	9393	1283
15°C	Kcal / hm	310	500	553	726	921	1292	400	643	706	918	1176	1644	486	782	846	1104	1410	1978	543	904	985	1267	1642	2261	642	1048	1135	1471	1892	2594	766	1235	1332	1736	2219	3033
	Watt / m	361	582	643	845	1072	1502	465	748	821	1068	1368	1912	565	909	984	1284	1640	2301	632	1051	1145	1473	1910	2630	746	1219	1320	1711	2200	3017	891	1437	1549	2020	2581	3528
	Btu / hm	1230	1985	2194	2882	3656	5127	1586	2554	2801	3645	4666	6523	1927	3103	3358	4380	5595	7850	2155	3587	3908	5026	6516	8972	2546	4160	4505	5839	7508	1029	3041	4902	5285	6891	8806	1203
18°C	Kcal / hm	289	467	516	678	860	1206	373	601	659	857	1097	1534	453	730	790	1030	1316	1846	507	844	919	1182	1532	2110	599	978	1059	1373	1766	2421	715	1153	1243	1621	2071	2831
	Watt / m	337	543	600	788	1000	1402	434	699	766	997	1276	1784	527	849	919	1198	1530	2147	589	981	1069	1375	1782	2454	696	1138	1232	1597	2054	2816	832	1341	1446	1885	2409	3292
	Btu / hm	1148	1853	2048	2690	3413	4785	1481	2383	2614	3402	4355	6088	1798	2896	3135	4088	5222	7327	2011	3348	3647	4691	6081	8374	2376	3882	4204	5450	7007	9608	2838	4575	4933	6432	8219	1123
20°C	Kcal / hm	273	441	488	641	813	1139	353	567	623	810	1037	1450	428	690	746	973	1243	1745	479	797	868	1117	1448	1994	566	924	1001	1298	1668	2288	676	1089	1175	1531	1957	2675
	Watt / m	318	513	567	745	945	1325	410	660	724	942	1206	1686	498	802	868	1132	1446	2029	557	927	1010	1299	1684	2319	658	1075	1164	1509	1940	2661	786	1267	1366	1781	2276	3111
	Btu / hm	1085	1750	1935	2542	3224	4521	1399	2252	2470	3214	4115	5753	1699	2737	2962	3863	4934	6923	1901	3163	3446	4432	5746	7913	2245	3668	3973	5150	6621	9079	2682	4323	4661	6077	7766	1061
22°C	Kcal / hm	259	418	462	607	770	1080	334	538	590	768	983	1374	406	654	707	922	1178	1653	454	755	823	1059	1372	1890	536	876	949	1230	1581	2168	641	1033	1113	1451	1855	2535
	Watt / m	301	486	537	706	896	1256	389	626	686	893	1143	1598	472	760	823	1073	1370	1923	528	879	957	1231	1596	2198	624	1019	1103	1430	1839	2522	745	1201	1295	1688	2157	2948
	Btu / hm	1028	1659	1834	2409	3056	4285	1326	2134	2341	3046	3900	5452	1610	2594	2807	3661	4676	6562	1801	2998	3266	4201	5446	7499	2128	3477	3765	4881	6275	8604	2542	4097	4417	5760	7360	1006
24°C	Kcal / hm	246	397	439	577	732	1026	318	511	561	730	934	1306	386	621	672	877	1120	1571	431	718	782	1006	1304	1796	510	833	902	1169	1503	2061	609	981	1058	1379	1763	2409
	Watt / m	286	462	511	671	851	1193	369	594	652	848	1086	1519	449	722	782	1020	1302	1828	502	835	910	1170	1517	2089	593	968	1049	1359	1748	2397	708	1141	1230	1604	2050	2802
	Btu / hm	977	1577	1743	2290	2904	4072	1260	2028	2225	2895	3706	5182	1531	2465	2668	3479	4444	6236	1712	2849	3104	3992	5176	7127	2022	3304	3578	4638	5964	8177	2416	3894	4198	5474	6995	9561

TABLE 2

THERMAL CAPACITY AT 60 °C AT 80 °C (90 °C/70 °C) WATER TEMPERATURE

HEIGHT (mm)		300						400						500						600						750						900					
TYPE		P	PK	PP	PKP	PKKP	PKKPKP	P	PK	PP	PKP	PKKP	PKKPKP	P	PK	PP	PKP	PKKP	PKKPKP	P	PK	PP	PKP	PKKP	PKKPKP	P	PK	PP	PKP	PKKP	PKKPKP	P	PK	PP	PKP	PKKP	PKKPKP
ROOM TEMPERATURE																																					
10° C	Kcal / hm	441	711	786	1033	1311	1838	569	915	1004	1306	1673	2338	691	1112	1204	1570	2005	2814	772	1286	1401	1801	2335	3216	913	1491	1615	2093	2691	3690	1090	1757	1894	2600	3323	4542
	Watt / m	513	827	915	1202	1524	2137	661	1065	1168	1519	1945	2719	803	1294	1400	1826	2332	3273	898	1495	1629	2095	2716	3740	1061	1734	1878	2434	3130	4291	1268	2044	2203	3024	3864	5282
	Btu / hm	1750	2823	3120	4100	5201	7292	2256	3632	3984	5184	6637	9279	2741	4414	4777	6230	7958	11166	3065	5102	5558	7149	9268	12762	3622	5917	6407	8306	10679	14643	4326	6973	7518	10318	13185	18022
12° C	Kcal / hm	420	678	749	984	1248	1750	542	872	956	1244	1593	2227	658	1059	1146	1495	1910	2680	736	1224	1334	1716	2224	3063	869	1420	1538	1993	2563	3514	1038	1673	1804	2352	3006	4109
	Watt / m	488	788	871	1144	1452	2035	630	1014	1112	1447	1853	2590	765	1232	1333	1739	2221	3117	856	1424	1551	1995	2587	3562	1011	1651	1788	2318	2981	4087	1207	1946	2098	2736	3496	4779
	Btu / hm	1667	2689	2972	3905	4953	6945	2149	3459	3795	4937	6321	8837	2610	4204	4550	5933	7579	10635	2919	4859	5294	6809	8826	12155	3449	5635	6102	7910	10170	13946	4120	6641	7160	9335	11929	16306
15° C	Kcal / hm	394	635	702	922	1170	1641	508	817	896	1166	1493	2088	617	993	1075	1402	1791	2512	690	1148	1251	1608	2085	2871	815	1331	1442	1869	2403	3295	973	1569	1691	2205	2818	3852
	Watt / m	458	739	817	1073	1361	1908	590	950	1043	1357	1737	2428	717	1155	1250	1630	2082	2922	802	1335	1454	1871	2425	3340	948	1548	1677	2173	2794	3832	1132	1825	1967	2565	3278	4480
	Btu / hm	1563	2521	2786	3661	4644	6511	2015	3243	3558	4629	5926	8285	2447	3941	4265	5562	7105	9970	2737	4555	4963	6383	8275	11395	3234	5283	5721	7416	9535	13074	3862	6226	6712	8751	11184	15287
18° C	Kcal / hm	368	593	655	861	1092	1531	474	763	837	1089	1394	1949	576	927	1003	1308	1671	2345	644	1071	1167	1501	1946	2680	761	1242	1346	1744	2243	3075	908	1464	1579	2058	2630	3595
	Watt / m	427	690	762	1001	1270	1781	551	887	973	1266	1621	2266	669	1078	1167	1522	1944	2727	749	1246	1358	1746	2263	3117	885	1445	1565	2028	2608	3576	1056	1703	1836	2394	3059	4181
	Btu / hm	1458	2353	2600	3417	4334	6077	1880	3027	3320	4320	5531	7732	2284	3678	3981	5192	6632	9305	2555	4251	4632	5957	7723	10635	3018	4930	5339	6921	8899	12203	3605	5811	6265	8168	10438	14268
20° C	Kcal / hm	347	560	619	814	1032	1447	448	721	791	1029	1317	1841	544	876	948	1236	1579	2216	608	1012	1103	1419	1839	2532	719	1174	1271	1648	2119	2905	858	1384	1492	1945	2485	3397
	Watt / m	404	652	720	946	1200	1683	521	838	919	1196	1532	2141	632	1019	1102	1438	1836	2577	707	1177	1283	1650	2139	2945	836	1365	1479	1917	2464	3379	998	1609	1735	2262	2891	3951
	Btu / hm	1378	2223	2457	3228	4095	5742	1777	2860	3137	4082	5226	7306	2158	3475	3761	4905	6266	8793	2414	4017	4377	5629	7297	10049	2852	4659	5045	6540	8409	11530	3406	5490	5919	7718	9863	13481
22° C	Kcal / hm	329	531	587	771	978	1371	424	683	749	975	1248	1745	515	830	898	1172	1497	2100	576	959	1045	1344	1743	2400	681	1113	1205	1562	2008	2754	813	1311	1414	1843	2356	3220
	Watt / m	383	617	682	897	1137	1595	493	794	871	1134	1452	2029	599	965	1045	1363	1740	2442	670	1116	1216	1564	2027	2791	792	1294	1401	1817	2336	3203	946	1525	1644	2144	2740	3745
	Btu / hm	1306	2107	2329	3060	3881	5442	1684	2711	2974	3869	4953	6924	2045	3294	3565	4649	5939	8333	2288	3807	4148	5335	6916	9524	2703	4415	4782	6198	7969	10928	3228	5204	5610	7315	9348	12777
24° C	Kcal / hm	313	505	558	733	929	1303	403	649	712	927	1186	1658	490	789	854	1113	1422	1996	548	912	993	1278	1656	2281	647	1057	1145	1484	1909	2617	773	1246	1344	1752	2239	3060
	Watt / m	364	587	649	852	1081	1516	469	755	828	1078	1380	1929	570	917	993	1295	1654	2321	637	1060	1155	1486	1926	2653	753	1230	1332	1726	2220	3044	899	1449	1563	2037	2604	3559
	Btu / hm	1241	2002	2213	2908	3688	5172	1600	2576	2826	3677	4707	6581	1944	3130	3388	4418	5644	7919	2174	3618	3942	5070	6573	9051	2569	4196	4544	5891	7574	10385	3068	4945	5332	6952	8884	12143

TABLE 3

WARRANTY CERTIFICATE

**REPUBLIC OF TURKEY
MINISTRY OF INDUSTRY AND TRADE
... PROVINCIAL DIRECTORATE OF INDUSTRY AND TRADE****WARRANTY CERTIFICATE****Date and Number of Approval of the Certificate: 23 ... 2004****20882**

The Provincial Directorate of Industry and Trade of the Republic of Turkey permits the utilization of this certificate pursuant to the Notice regarding the Implementation Principles of the Warranty Certificates which was brought into force based on the Law regarding the Protection of the Consumers numbered 4077 and the same law.

Arif GÜLDANE
[SIGNATURE AND SEAL]
Provincial Deputy Director
On behalf of the Provincial Director

MANUFACTURER'S/IMPORTER'S:

TITLE : SANICA ISI SANAYİ A.Ş.
HEADQUARTERS : GÜRPINAR YOLU, KAVAKLI KÖYÜ, B. ÇEKMECE/IST
PHONE : 0 212 876 60 60 (10 Lines)
FAX : 0 212 876 60 70

AUTHORIZED PERSON'S :
SIGNATURE AND SEAL : [SIGNATURE AND SEAL]

PROPERTY'S:

TYPE : RADIATOR
TRADEMARK : SANICA
MODEL : ATTACHED LIST
BANDEROL AND SERIAL NO. :
DATE AND PLACE OF DELIVERY :
WARRANTY PERIOD : 12 YEARS
MAXIMUM REPARATION PERIOD : 7 BUSINESS DAYS

SELLER'S :
TITLE :
ADDRESS :
PHONE :
FAX :
DATE AND NUMBER OF INVOICE :

ISO CERTIFICATE



TURKISH STANDARDS COMPLIANCE CERTIFICATE

INSTITUTE OF TURKISH STANDARDS
TURKISH STANDARDS COMPLIANCE CERTIFICATE

DOCUMENT NO.: 34.14.01/7279

DATE OF ISSUANCE: 04/10/2004

NAME AND ADDRESS OF THE COMPANY: SANICA ISI SANAYİ A.Ş. – KAVAKLI KÖYÜ GÜRPINAR YOLU
ÜZERİ 34528 BÜYÜKÇEKMECE/ISTANBULADDRESS OF THE MANUFACTURING SITE: KAVAKLI KÖYÜ GÜRPINAR YOLU ÜZERİ 34528
BÜYÜKÇEKMECE/ISTANBULRELATED TURKISH STANDARD: TS EN 442-1/MARCH 1998 “RADIATORS AND CONVECTORS – SECTION
1: TECHNICAL SPECIFICATIONS AND RULES”TRADEMARK, NAME, CLASS, TYPE, DESIGNATION AND SPECIFICATIONS OF THE PRODUCT
PERMITTED TO HAVE TSE MARK

TRADEMARK: “DESİGN PERFECTION SANICA RADIATOR”

- RADIATOR HEIGHT 600 MM; PKKP22, PKP21, PK11, PKKPKP33 TYPES, MAX. OPERATION PRESSURE 7.7 BAR; RADIATORS MANUFACTURED FROM STEEL SHEETS
- RADIATOR HEIGHT 400 MM AND 480 MM; PKKP22, PKP21, PK11 TYPES AND RADIATOR HEIGHT 900; PKKP22 TYPE, MAX. OPERATION PRESSURE 7.7 BAR; RADIATORS MANUFACTURED FROM STEEL SHEETS (27/01/2005) K.G

04/10/2004	04/10/2005	04/10/2006		
ANNUAL VISA [SIGNATURE AND SEAL]	ANNUAL VISA [SIGNATURE AND SEAL]	ANNUAL VISA [SIGNATURE AND SEAL]		

Erol TURHAN
TSE QUALITY CAMPUS
PRODUCT CERTIFICATION
DIRECTOR
[SIGNATURE]Erdoğan TUNCER
TSE QUALITY CAMPUS
DEPUTY REGIONAL DIRECTOR
[SIGNATURE]Fedai ÇETİN
TSE QUALITY CAMPUS
DEPUTY REGIONAL
DIRECTOR
[SIGNATURE]

This document is valid for 1 year starting from the latest visa date. The certificate without annual visa shall be invalid.
This document may not be damaged or copied partially or in a way decreasing legibility and may not be translated without
the permit of the Institute of the Turkish Standards.

Necatibey Caddesi No.: 112 06100 Bakanlıklar – Ankara – TURKEY Phone: +90 312 417 35 80 Fax: +90 312 425 43 50
Email: belge@tse.org.tr

**INSTITUTE OF TURKISH STANDARDS
CERTIFICATE OF COMPETENCY FOR MANUFACTURING****DOCUMENT NO.:****DATE OF ISSUANCE:**04/10/2004**NAME AND ADDRESS OF THE COMPANY:**SANİCA ISI SANAYİ A.Ş. – KAVAKLI KÖYÜ GÜRPINAR YOLU ÜZERİ 34528 BÜYÜKÇEKMECE-İSTANBUL/ TURKEY.....**ADDRESS OF THE MANUFACTURING SITE:**KAVAKLI KÖYÜ GÜRPINAR YOLU ÜZERİ 34528 BÜYÜKÇEKMECE-İSTANBUL/ TURKEY.....**INDUSTRY REGISTRY NO.:****TRADE REGISTRY NO.:** 613

THIS CERTIFICATE WAS ISSUED AS A RESULT OF THE EXAMINATION CONDUCTED ON THE MATERIALS AND PRODUCTS TO BE MANUFACTURED COMPETENTLY BY THE COMPANY WHICH HAS ITS NAME AND ADDRESS GIVEN ABOVE PURSUANT TO THE LAW NUMBERED 132 AND THE CODE OF THE INSTITUTE OF TURKISH STANDARDS.

Fedai ÇETİN
TSE QUALITY CAMPUS
DEPUTY REGIONAL DIRECTOR
[SIGNATURE]

TRADEMARK, NAME, TYPE AND SPECIFICATIONS OF THE PRODUCT IN SCOPE OF THE CERTIFICATE
TS EN 442-1

RELATED TURKISH STANDARD: TS EN 442-1/MARCH 1998 “RADIATORS AND CONVECTORS – SECTION 1: TECHNICAL SPECIFICATIONS AND RULES”

TRADEMARK: “DESİGN PERFECTION SANİCA RADIATOR”

- RADIATOR HEIGHT 600 MM; PKKP22, PKP21, PK11, PKKP33 TYPES, MAX. OPERATION PRESSURE 7.7 BAR; RADIATORS MANUFACTURED FROM STEEL SHEETS
- RADIATOR HEIGHT 400 MM AND 480 MM; PKKP22, PKP21, PK11 TYPES AND RADIATOR HEIGHT 900; PKKP22 TYPE, MAX. OPERATION PRESSURE 7.7 BAR; RADIATORS MANUFACTURED FROM STEEL SHEETS (27/01/2005) K.G

TRADEMARK: “SANİCA COMBO”

TS EN 625/TS EN 483

TS EN 625/SEPTEMBER 1995 “CENTRAL HEATING BOILERS BURNING GASES – COMBINED BOILERS WHICH HAVE NOMINAL HEAT LOADS NOT EXCEEDING 70 kW (COMBINED HEATING DEVICES “COMBI”), SPECIFIC CONDITIONS FOR HOT UTILIZATION WATER PRODUCTION

TS EN 483/MARCH 2001 “BOILERS – CENTRAL HEATING – GAS BURNING – C TYPE BOILERS WHICH HAVE NOMINAL HEAT LOADS NOT EXCEEDING 70 kW

- C12 TYPE (HERMETIC) ELECTRONIC COMBUSTION, HOT UTILIZATION WATER PRODUCTION, SUDDEN HEATING GAS CATEGORY: CENTRAL HEATING BOILERS OF II 2H3B/9, COMBO S 24 kW; SUPER COMBO S 24 kW; SUPER COMBO S 30 kW MODELS

04/10/2006				
ANNUAL VISA [SIGNATURE AND SEAL]				

This document is valid for 1 year starting from the latest visa date. The certificate without annual visa shall be invalid.
This document may not be damaged or copied partially or in a way decreasing legibility and may not be translated without the permit of the Institute of the Turkish Standards.