

# NEXIS CLICK-ON

Placute de montaj

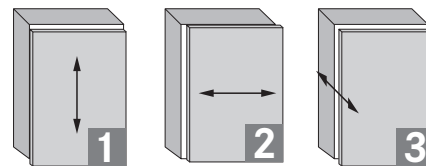
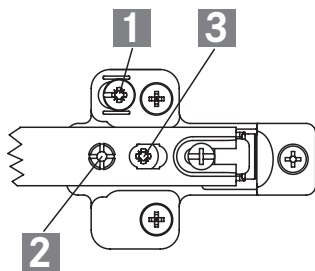

Reglarea  
inaltimii  
+/-2 mm

Reglare  
laterala  
+1/-3 mm

Reglarea  
adancimii  
+3/-1 mm

Toate reglajele se pot face independent unul fata de celalalt

## INFORMATII COMANDA

### 2D PLACUTE DE MONTAJ IN CRUCE, 3-PUNCTE DE FIXARE

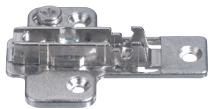
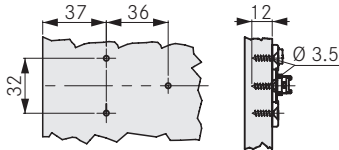
Pentru montare prin insurubare	37/32	Inaltime	Articol nr.
<ul style="list-style-type: none"> <li>Otel/Zamak/nichelat</li> <li>Prindere cu holtzsuruburi</li> <li>Distanta de montare 37 mm</li> <li>Distanta intre gauri 32 mm</li> <li>Reglarea adancimii si a inaltimii prin came</li> </ul> 		0	<b>F061073214</b>
		2	<b>F061073215</b>
		4	<b>F061073216</b>
		6	<b>F061073217</b>
		8	<b>F061073218</b>

### 2D PLACUTE DE MONTAJ IN CRUCE, 3-PUNCTE DE FIXARE

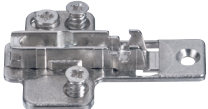
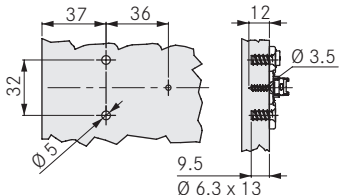
Pentru montare cu eurosuruburi preasamblate	37/32	Inaltime	Articol nr.
<ul style="list-style-type: none"> <li>Otel/Zamak/nichelat</li> <li>Prindere Pentru montare cu eurosuruburi preasamblate</li> <li>Distanta de montare 37 mm</li> <li>Distanta intre gauri 32 mm</li> <li>Reglarea adancimii si a inaltimii prin came</li> </ul> 		0	<b>F061073232</b>
		2	<b>F061073233</b>
		4	<b>F061073234</b>

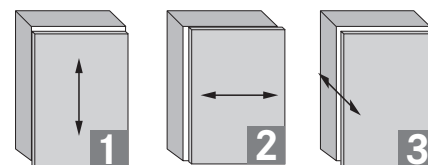
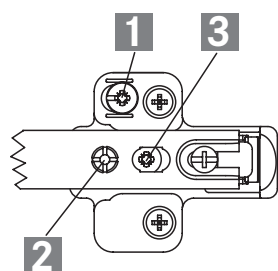

Reglarea  
inaltimii  
+/-2 mm

Reglare  
laterală  
+1/-3 mm

Reglarea  
adancimii  
+3/-1 mm

Toate reglajele se pot face independent  
unul fata de celalalt

## INFORMATII COMANDA

### 2D PLACUTE DE MONTAJ IN CRUCE, 2-PUNCTE DE FIXARE

Pentru montare prin insurubare	37/32	Inaltime	Articol nr.
<ul style="list-style-type: none"> <li>Otel/Zamak/nichelat</li> <li>Prindere cu holtzsuruburi</li> <li>Distanța de montare 37 mm</li> <li>Distanța între gauri 32 mm</li> <li>Reglarea adancimii și a înalțimii prin came</li> </ul>		0	F061073253
		2	F061073254
		3	F061073295
		4	F061073255
		6	F061073222
		8	F061073223

### 2D PLACUTE DE MONTAJ IN CRUCE, 2-PUNCTE DE FIXARE

Pentru montare cu eurosuruburi	37/32	Inaltime	Articol nr.
<ul style="list-style-type: none"> <li>Otel/Zamak/nichelat</li> <li>Prindere cu eurosuruburi</li> <li>Distanța de montare 37 mm</li> <li>Distanța între gauri 32 mm</li> <li>Reglarea adancimii și a înalțimii prin came</li> </ul>		0	F061073227
		2	F061073228
		4	F061073229
		6	F061073230
		8	F061073231

### 2D PLACUTE DE MONTAJ IN CRUCE, 2-PUNCTE DE FIXARE

Pentru montare cu eurosuruburi preasamblate	37/32	Inaltime	Articol nr.
<ul style="list-style-type: none"> <li>Otel/Zamak/nichelat</li> <li>Prindere Pentru montare cu eurosuruburi preasamblate</li> <li>Distanța de montare 37 mm</li> <li>Distanța între gauri 32 mm</li> <li>Reglarea adancimii și a înalțimii prin came</li> </ul>		0	F061073236
		2	F061073237
		3	F061073294
		4	F061073238
		6	F061073239
		8	F061073240

### 2D PLACUTE DE MONTAJ IN CRUCE, 2-PUNCTE DE FIXARE

Pentru montare cu dibluri prin presare	37/32	Inaltime	Articol nr.
<ul style="list-style-type: none"> <li>Otel/Zamak/nichelat</li> <li>Prindere cu dibluri de 10 mm</li> <li>Distanța de montare 37 mm</li> <li>Distanța între gauri 32 mm</li> <li>Reglarea adancimii și a înalțimii prin came</li> </ul>		0	F061073248
		2	F061073249
		4	F061073250

# NEXIS CLICK-ON

Placute de montaj

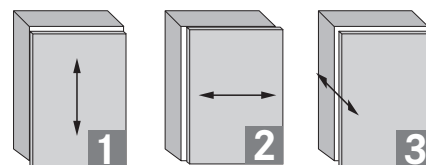
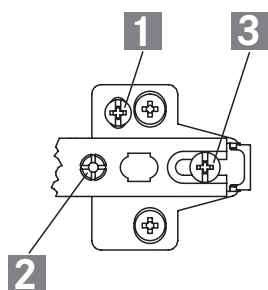

Reglarea  
inaltimii  
+/-2 mm

Reglare  
laterala  
+1/-3 mm

Reglarea  
adancimii  
+3/-1 mm

Toate reglajele se pot face independent  
unul fata de celalalt

## INFORMATII COMANDA

### 2-D PLACUTE DE MONTAJ IN CRUCE, 3-PUNCTE DE FIXARE

Pentru montare prin insurubare	37/32	Inaltime	Articol nr.
<ul style="list-style-type: none"> <li>Otel/Zamak/nichelat</li> <li>Prindere cu holtzsuruburi</li> <li>Distanta de montare 37 mm</li> <li>Distanta intre gauri 32 mm</li> </ul>		0	<b>F060073148</b>
		2	<b>F060073150</b>
		4	<b>F060073151</b>
		8	<b>F060073152</b>
		18	<b>F060073153</b>

### 2-D PLACUTE DE MONTAJ IN CRUCE, 3-PUNCTE DE FIXARE

Pentru montare cu eurosuruburi	37/32	Inaltime	Articol nr.
<ul style="list-style-type: none"> <li>Otel/Zamak/nichelat</li> <li>Prindere cu eurosuruburi</li> <li>Distanta de montare 37 mm</li> <li>Distanta intre gauri 32 mm</li> </ul>		0	<b>F060073156</b>
		2	<b>F060073157</b>
		4	<b>F060073158</b>
		8	<b>F060073159</b>
		18	<b>F060073160</b>

### DISTANTIER, INALTIME 3

Pentru montare cu eurosuruburi	37/32	Inaltime	Articol nr.
<ul style="list-style-type: none"> <li>Plastic, negru</li> <li>Poate fi stivuit</li> <li>Pentru placile 2-d otel/Zamak</li> </ul>		3	<b>F069073764</b>

### 2-D PLACUTE DE MONTAJ IN CRUCE, 3-PUNCTE DE FIXARE

Pentru montare cu eurosuruburi preasamblate	37/32	Inaltime	Articol nr.
<ul style="list-style-type: none"> <li>Otel/Zamak/nichelat</li> <li>Prindere Pentru montare cu eurosuruburi preasamblate</li> <li>Distanta de montare 37 mm</li> <li>Distanta intre gauri 32 mm</li> </ul>		0	<b>F060073171</b>
		2	<b>F060073172</b>
		4	<b>F060073173</b>
		8	<b>F060073174</b>
		18	<b>F060073175</b>

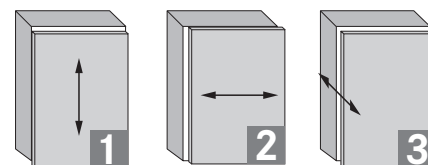
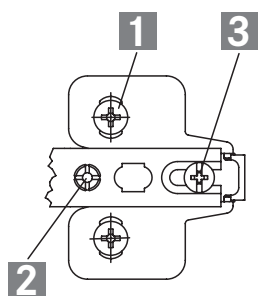

Reglarea  
inaltimii  
+/-2 mm

Reglare  
laterală  
+1/-3 mm

Reglarea  
adancimii  
+3/-1 mm

Toate reglajele se pot face independent  
unul fata de celalalt

## INFORMATII COMANDA

### 1-D PLACUTE DE MONTAJ IN CRUCE, 2-PUNCTE DE FIXARE

Pentru montare prin insurubare	37/32	Inaltime	Articol nr.
<ul style="list-style-type: none"> <li>Otel, nichelat</li> <li>Prindere cu holtzsuruburi</li> <li>Distanța de montare 37 mm</li> <li>Distanța între gauri 32 mm</li> <li>Ajustarea înalțimii prin interior</li> </ul>		0	F060073144
		2	F060073145
		3	F060073209
		4	F060073146

### 1-D PLACUTE DE MONTAJ IN CRUCE, 2-PUNCTE DE FIXARE

Pentru montare cu eurosuruburi preasamblate	37/32	Inaltime	Articol nr.
<ul style="list-style-type: none"> <li>Otel, nichelat</li> <li>Prindere Pentru montare cu eurosuruburi preasamblate cu lungimea de 13.5 mm</li> <li>Distanța de montare 37 mm</li> <li>Distanța între gauri 32 mm</li> <li>Ajustarea înalțimii prin interior</li> </ul>		0	F060073179
		2	F060073180
		3	F060073211
		4	F060073181

### 1-D PLACUTE DE MONTAJ IN CRUCE, 2-PUNCTE DE FIXARE PENTRU APLICATII DUBLE

Pentru montare cu eurosuruburi preasamblate	37/32	Inaltime	Articol nr.
<ul style="list-style-type: none"> <li>Otel, nichelat</li> <li>Prindere Pentru montare cu eurosuruburi preasamblate cu lungimea de 10.5 mm</li> <li>Distanța de montare 37 mm</li> <li>Distanța între gauri 32 mm</li> <li>Ajustarea înalțimii prin interior</li> <li>Pentru aplicatie dubla</li> </ul>		0	F060073201
		2	F060073202
		4	F060073203

# NEXIS CLICK-ON

Placute de montaj

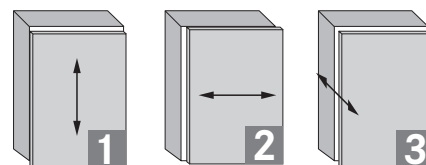
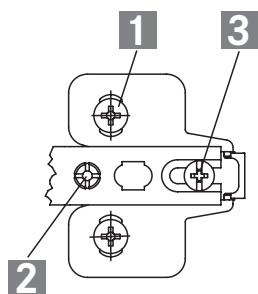

Reglarea  
inaltimii  
+/-2 mm

Reglare  
laterala  
+1/-3 mm

Reglarea  
adancimii  
+3/-1 mm

Toate reglajele se pot face independent unul fata de celalalt

## INFORMATII COMANDA

### 1-D PLACUTE DE MONTAJ IN CRUCE, 3-PUNCTE DE FIXARE

Pentru montare cu diblu de expandare		37/32	Inaltime	Articol nr.
<ul style="list-style-type: none"> <li>Otel, nichelat</li> <li>Prindere Pentru montare cu diblu de expandare de 5 mm</li> <li>Distanța de montare 37 mm</li> <li>Distanța între gauri 32 mm</li> <li>Ajustarea înalțimii prin interior</li> </ul>	<p>ⓘ Plate must not be fixed with a cordless screwdriver.</p>		0	<b>F060073185</b>
			2	<b>F060073186</b>
			4	<b>F060073187</b>

### 1-D PLACUTE DE MONTAJ IN CRUCE, 2-PUNCTE DE FIXARE

Pentru montare cu diblu prin presare		37/32	Inaltime	Articol nr.
<ul style="list-style-type: none"> <li>Otel, nichelat</li> <li>Prindere cu dibluri de 10 mm</li> <li>Distanța de montare 37 mm</li> <li>Distanța între gauri 32 mm</li> <li>Ajustarea înalțimii prin interior</li> </ul>			0	<b>F060073188</b>
			2	<b>F060073191</b>
			4	<b>F060073190</b>

### 1-D PLACUTE DE MONTAJ IN CRUCE, 2-PUNCTE DE FIXARE

Pentru montare cu diblu de expandare		37/32	Inaltime	Articol nr.
<ul style="list-style-type: none"> <li>Otel, nichelat</li> <li>Prindere Pentru montare cu diblu de expandare de 5 mm bridge</li> <li>Distanța de montare 37 mm</li> <li>Distanța între gauri 32 mm</li> <li>Ajustarea înalțimii prin interior</li> </ul>			0	<b>F060073182</b>
			2	<b>F060073183</b>
			4	<b>F060073184</b>

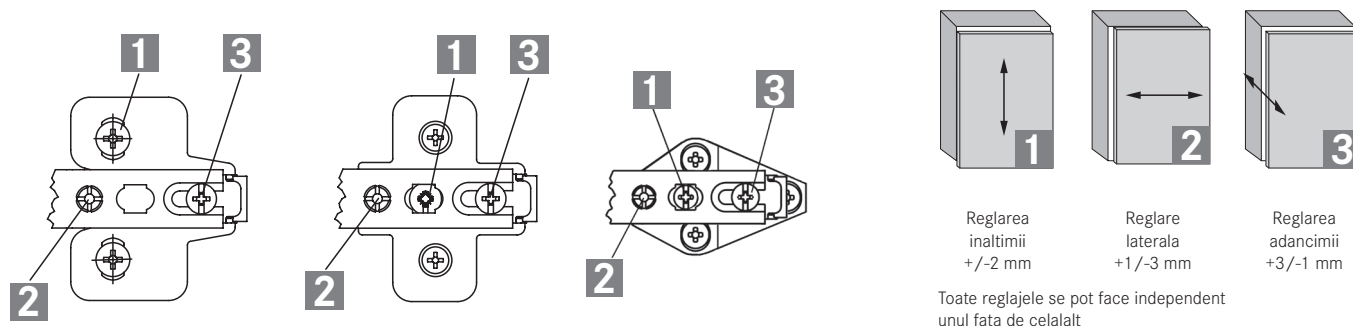

## INFORMATII COMANDA

1-D PLACA MONTAJ, 2-PUNCTE DE FIXARE, DISTANTA DE MONTARE 28 MM

Pentru montare prin insurubare	28/32	Inaltime	Articol nr.
<ul style="list-style-type: none"> <li>Otel, nichelat</li> <li>Prindere cu holtzsuruburi</li> <li>Distanta de montare 28 mm</li> <li>Distanta intre gauri 32 mm</li> <li>Ajustarea inaltimii prin interior</li> </ul>		0	<b>F060073139</b>
		2	<b>F060073140</b>
		4	<b>F060073141</b>

1-D PLACA MONTAJ, 2-PUNCTE DE FIXARE, DISTANTA DE MONTARE 28 MM

Pentru montare cu eurosuruburi preasamblate	28/32	Inaltime	Articol nr.
<ul style="list-style-type: none"> <li>Otel, nichelat</li> <li>Prindere Pentru montare cu eurosuruburi preasamblate</li> <li>Distanta de montare 28 mm</li> <li>Distanta intre gauri 32 mm</li> <li>Ajustarea inaltimii prin interior</li> </ul>		0	<b>F060073162</b>
		2	<b>F060073163</b>
		4	<b>F060073164</b>

2-D PLACA MONTAJ, 2-PUNCTE DE FIXARE, DISTANTA DE MONTARE 28 MM

Pentru montare cu eurosuruburi	28/32	Inaltime	Articol nr.
<ul style="list-style-type: none"> <li>Otel/Zamak/nichelat</li> <li>Prindere cu eurosuruburi</li> <li>Distanta de montare 28 mm</li> <li>Distanta intre gauri 32 mm</li> <li>Reglare inaltime</li> </ul>		2	<b>F060073154</b>
		4	<b>F060073155</b>

1-D PLACA MONTAJ, 2-PUNCTE DE FIXARE, DISTANTA DE MONTARE 37 MM, DISTANTA INTRE GAURI 25 MM

Pentru montare cu eurosuruburi	37/25	Inaltime	Articol nr.
<ul style="list-style-type: none"> <li>Zamak, nichelat</li> <li>Prindere cu eurosuruburi</li> <li>Distanta de montare 37 mm</li> <li>Distanta intre gauri 25 mm</li> <li>Reglare inaltime</li> </ul>		2	<b>F061073268</b>

# NEXIS CLICK-ON

Placute de montaj

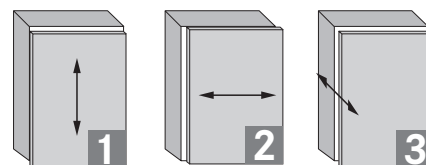
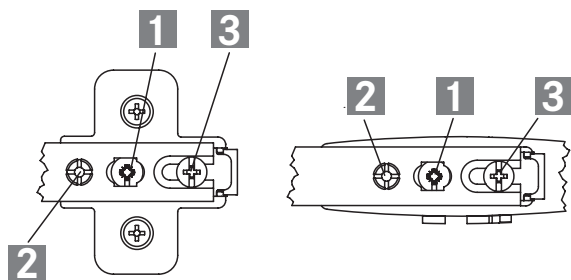

Reglarea  
inaltimii  
+/-2 mm

Reglare  
laterala  
+1/-3 mm

Reglarea  
adancimii  
+3/-1 mm

Toate reglajele se pot face independent unul fata de celalalt

## INFORMATII COMANDA

### PLACUTE DE MONTAJ IN CRUCE PENTRU UNGHI DE 20°, 2-PUNCTE DE FIXARE

Pentru montare cu eurosuruburi preasamblate	X/32	Inaltime	Articol nr.
<ul style="list-style-type: none"> <li>Pentru unghi deschidere de 20°</li> <li>Zamak, nichelat</li> <li>Prindere Pentru montare cu eurosuruburi preasamblate</li> <li>Distanta intre gauri 32 mm</li> <li>Reglare inaltime</li> </ul>		2	<b>F061073273</b>
		4	<b>F061073274</b>

### PLACUTE DE MONTAJ IN CRUCE PENTRU UNGHI DE 45°, 2-PUNCTE DE FIXARE

Pentru montare cu eurosuruburi	X/32	Inaltime	Articol nr.
<ul style="list-style-type: none"> <li>Pentru unghi deschidere de 45°</li> <li>Zamak, nichelat</li> <li>Prindere cu eurosuruburi</li> <li>Distanta intre gauri 32 mm</li> <li>Reglare inaltime</li> </ul>		2	<b>F061073271</b>
		4	<b>F061073272</b>

### 1D PLACA MONTAJ LINIARA, 2-PUNCTE DE FIXARE

Pentru montare prin insurubare	13.5/32	Inaltime	Articol nr.
<ul style="list-style-type: none"> <li>Otel/Zamak/nichelat</li> <li>Prindere cu holtzsuruburi</li> <li>Reglare inaltime prin came</li> </ul>		0	<b>F060073129</b>
		2	<b>F060073130</b>
		3	<b>F060073212</b>
		4	<b>F060073205</b>

### 1D PLACA MONTAJ LINIARA, 2-PUNCTE DE FIXARE

Pentru montare cu diblu prin presare	13.5/32	Inaltime	Articol nr.
<ul style="list-style-type: none"> <li>Otel/Zamak/nichelat</li> <li>Prindere cu dibluri de 10 mm</li> <li>Reglare inaltime prin came</li> </ul>		0	<b>F060073136</b>
		2	<b>F060073137</b>
		3	<b>F060073210</b>
		4	<b>F060073138</b>

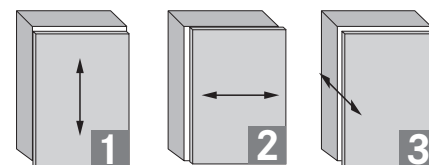
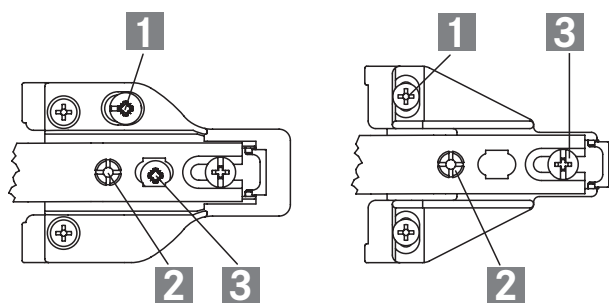

Reglarea  
inaltimii  
+/-2 mm

Reglare  
laterala  
+1/-3 mm

Reglarea  
adancimii  
+3/-1 mm

Toate reglajele se pot face independent unul fata de celalalt

## INFORMATII COMANDA

### 2D PLACA MONTAJ SPECIALA PENTRU CONSTRUCTIE CADRU

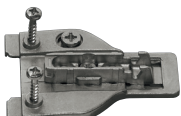
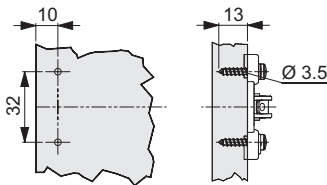
Pentru montare cu holtzsuruburi preasamblate	10/32	Inaltime	Articol nr.
<ul style="list-style-type: none"> <li>Otel/Zamak/nichelat</li> <li>Prindere cu holtzsuruburi preasamblate</li> <li>Reglarea adancimii si a inaltimei prin came</li> </ul> 		0	<b>F061073283</b>
		2	<b>F061073284</b>
		4	<b>F061073285</b>

### 2D PLACA MONTAJ SPECIALA PENTRU CONSTRUCTIE CADRU

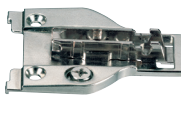
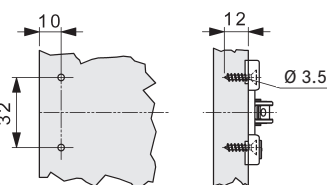
Pentru montare prin insurubare	10/32	Inaltime	Articol nr.
<ul style="list-style-type: none"> <li>Otel/Zamak/nichelat</li> <li>Prindere cu holtzsuruburi</li> <li>Reglarea adancimii si a inaltimei prin came</li> </ul> 		0	<b>F061073279</b>
		2	<b>F061073280</b>
		4	<b>F061073281</b>

### PLACA MONTAJ SPECIALA PENTRU CONSTRUCTIE CADRU

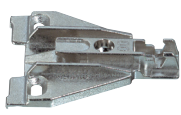
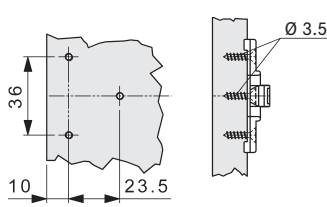
Pentru montare prin insurubare	10/36	Inaltime	Articol nr.
<ul style="list-style-type: none"> <li>Zamak, nichelat</li> <li>Prindere cu holtzsuruburi</li> <li>Ajustarea inaltimei prin interior</li> </ul> 		0	<b>F061073275</b>
		2	<b>F061073276</b>
		4	<b>F061073277</b>

### 2-D PLACA MONTAJ SPECIALA PENTRU CONSTRUCTIE CADRU

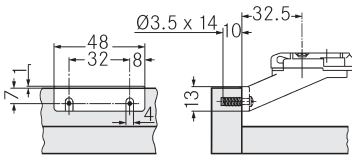
Pentru montare prin insurubare		Inaltime	Articol nr.
<ul style="list-style-type: none"> <li>Pentru usi incadrate</li> <li>pentru balamale cu umar 8</li> <li>Zamak, nichelat</li> <li>Prindere cu holtzsuruburi</li> <li>Reglare inaltime</li> </ul> 		2	<b>F061073278</b>