

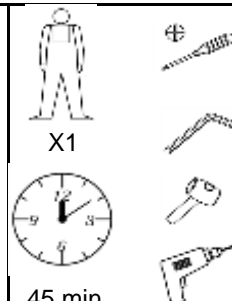

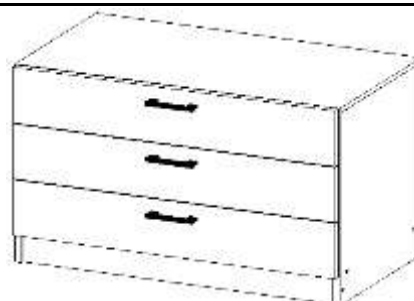









Va rugam, dupa ce deschideti coletul, sa verificati daca sunt toate accesoriile de feronerie, precum si existenta numarului de piese mentionate in schita de montaj. In cazul constatarii lipsurilor (feronerie, piese) sau defectiunilor va rugam sa anuntati personalul Arabesque Home in termen de 24 ore de la achizitionarea produsului, comunicand lipsurile si defectiunile constatate si numarul stampilei C.T.C. de pe ambalaj. In cazul necomunicarii defectiunilor sau lipsurilor constatate in termenul de mai sus, SC LUX-ARTIM SRL nu-si asuma raspunderea pentru eventualele neconformitati. Va multumim pentru intelegere.

MIC MOBILIER  
COMODA 3SERTARE 800X450X700 (MM16W/MM16S/MM16M)  
VERSIUNEA: 02/22.08.2018



	
<b>A - Eurosurub 7x50 - 6buc</b>	<b>G - Maner satin - 3buc</b>
	
<b>B - Eurosurub 5x50 - 24buc</b>	<b>H - Surub maner 4X40- 6buc</b>
	
<b>C - Holtz 4x30 - 6buc</b>	<b>I - Cuie Hdf 2x20- 50buc</b>
	
<b>D - Holtz 3.5x16 - 48buc</b>	<b>J - Cheie imbus 4mm - 1buc</b>
	
<b>E - Set Glisiere 400 - 3buc</b>	<b>K - Cheie imbus 3mm - 1buc</b>
	
<b>F - Excentric 15x32 - 4buc</b>	<b>L- Capacele autoadezive -6buc</b>

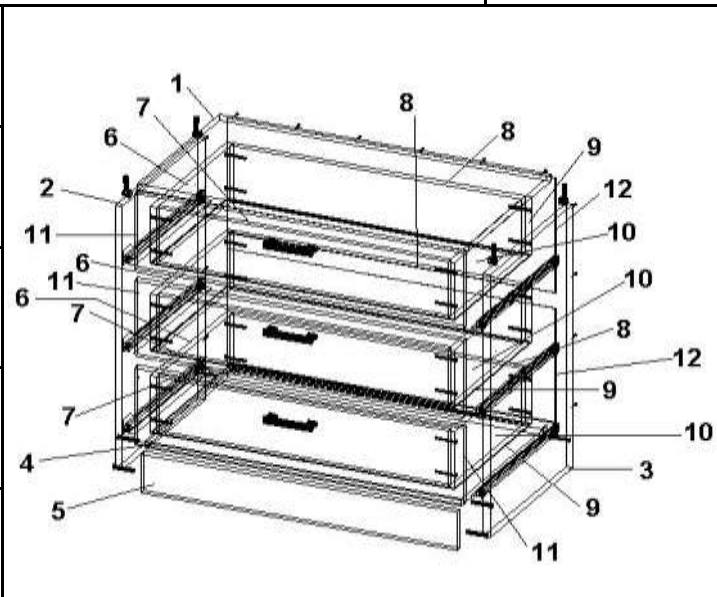

1 - Placa capac	9 - Laterala sertar -3buc
2 - Laterala	10 - Fund sertar - 3buc
3 - Laterala	11 - Fata sertar - 3buc
4 - Placa fund	12 - Spate Hdf 2buc
5 - Plinta	
6 - Laterala sertar - 3buc	
7 - Fata interior sertar - 3buc	
8 - Spate sertar - 3buc	

1. Se monteaza pe lateralele 2 si 3 glisierele E folosind holtzsuruburi D si excentrici F.
2. Se prinde placa fund 4 de lateralele 2 si 3 cu eurosuruburi A.
3. Se prinde plinta 5 de lateralele 2 si 3 cu eurosuruburi A.
4. Se fixeaza excentrici F pe placa capac 1 si se prinde de lateralele 2 si 3.
5. Se prinde spatele Hdf 12 de lateralele 2 si 3, placa capac 1 si placa fund 4, folosind cuiele Hdf I.
6. Se prinde laterala sertar 6 de spate sertar 8, fata interior sertar 7 si laterala sertar 9, folosind eurosuruburi B.
7. Se prinde fund sertar 10 de ansamblul montat anterior, folosind cuie Hdf I.
8. Se fixeaza pe fundul sertarului glisiera E cu holtzsuruburile D.
9. Se aseaza sertarul pe glisierele E de pe lateralele 2 si 3.
10. Se fixeaza fata sertar 11 de interior sertar 7 cu surub maner H odata cu manerul G.
11. Se lipest capacele L pe eurosuruburile A vizibile.