

BENEFITS:

- Wide range of operating temperatures, from -10°C to +60°C
- Long shelf life of 10 years

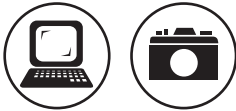

APPLICATIONS BEST FOR:



- **GP Lithium Cell Battery**
- **3 Volts**

Other Details:

- Lithium Manganese Dioxide chemistry
- Button cell type
- Store lithium coin cells out of sight and reach of young children

CROSS REFERENCES:

IEC	GP/Energizer/Varta/Sony/Maxell	Duracell
CR1616	CR1616	1616

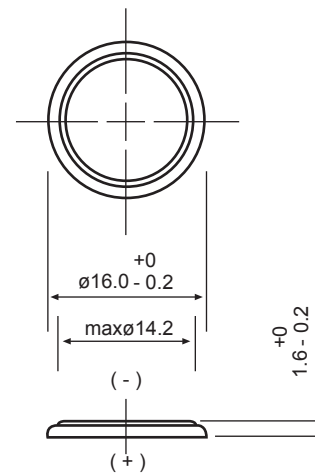

Unit : mm