

114,5

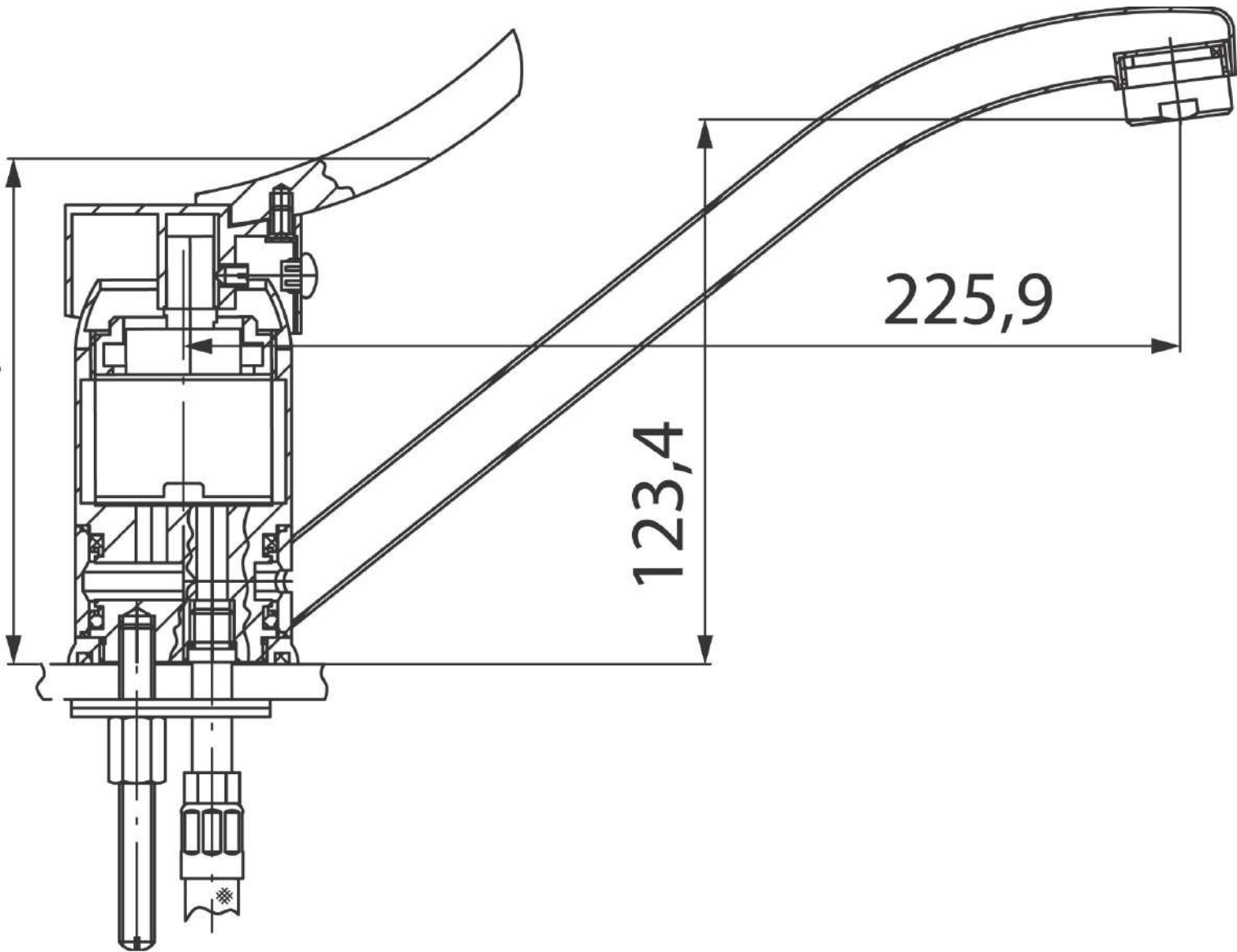

123,4

225,9