

Va rugam sa verificati continutul coletului, existenta accesoriilor de feronerie, precum si a pieselor mentionate in schita de montaj. In cazul constatarii lipsurilor (feronerie, piese) sau defectiunilor va rugam sa anuntati personalul LUX ARTIM in termen de 24 ore de la achizitionarea produsului, comunicand lipsurile si defectiunile constatate si numarul stampilei C.T.C. de pe ambalaj. In cazul necomunicarii defectiunilor sau lipsurilor constatate in termenul de mai sus, SC LUX-ARTIM SRL nu-si asuma raspunderea pentru eventualele neconformitati.

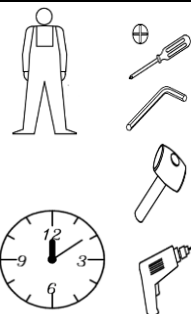

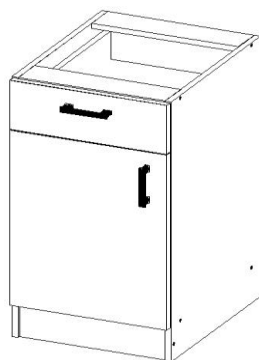







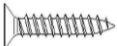

Va multumim pentru intelegere.

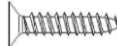
START

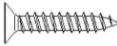
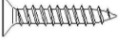
S4 - CORP BAZA 1SERTAR 1USA 80x40x50
VERSIUNEA: 01/30.04.2020



30 min

	
A - Eurosurub 5x50 – 18buc	H - Balama aplicata – 2buc
	
B - Holtzsurub 3.5x16 – 20buc	I – Surub maner 4x40 2buc
	
C - Holtzsurub 4x16 – 4buc	J - Cuie HDF - 28buc
	
D - Holtzsurub 4x18 – 4 buc	K- Holtzsurub 4x30 – 2 buc
	
E – Maner – 2buc	L-Glisiere 450mm-1set
	
F - Surub maner 25mm – 2 buc	M – Cheie imbus 6mm – 1buc
	
G-Picioar M6+bucsa-4buc	O-Capacele adezive -10 buc

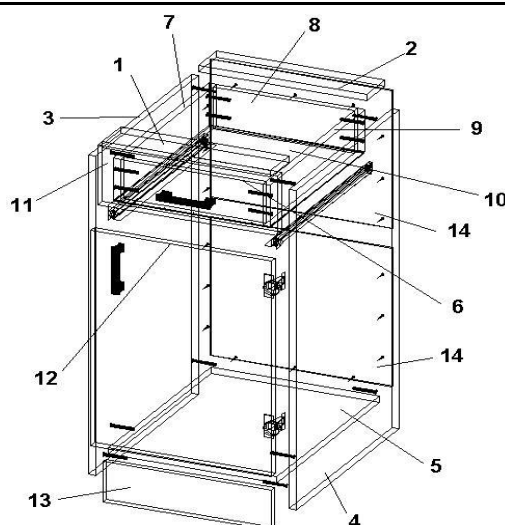

1 -Lonjeron fata	8-Spate sertar
2-Lonjeron spate	9-Laterala sertar
3-Laterala	10-Fund sertar
4-Laterala	11-Fata sertar
5-Placa fund	12-Usa
6-Fata interior sertar	13-Plinta
7-Laterala sertar	14-Spate HDF 2buc

Instructiuni de asamblare corp baza 1sertar 1usa

- Se fixeaza cele 4 buc picioare G pe lateralele 3 si 4, folosind cheia imbus de 6mm N
- Se cupleaza placa fund 5 cu lateralele 3 si 4 folosind 4buc eurosuruburi A.
- Se monteaza lonjeroanele 1 si 2 intre lateralele 3 si 4 cu eurosuruburi A.
- Se monteaza plinta 13 intre lateralele 3 si 4, folosind eurosuruburi A.
- Se monteaza sinele de la glisierile L pe lateralele 3 si 4 cu holtzsuruburile B.
- Se prind cele 2 placi spate Hdf 14 de lateralele 3 si 4, fundul 5 si lonjeronul 2 folosind cuie Hdf J.
- Se monteaza balamalele H pe usa 12 cu holtzsuruburi D.
- Se monteaza bratul balamalelor H pe laterala 4 folosind holtzsuruburi C.
- Se fixeaza manerul E pe usa 12 folosind suruburi F.
- Se cupleaza intre ele fata interior sertar 6, laterala sertar 7, spate sertar 8 si laterala 9 cu eurosuruburi A.
- Se prinde fund sertar 10 de cadrul asamblat anterior, folosind cuie Hdf J.
- Se monteaza glisierile L pe lateralele sertarului 7 si 9 cu holtzsuruburi B.
- Fata sertarului 11 se monteaza pe sertar, se fixeaza cu manerul E si suruburile I, apoi se fixeaza cu holtzsuruburile K.
- Se aplica capacele autoadezive O pe toate eurosuruburile vizibile.